

OWNER'S MANUAL

LOCK-N-LOAD[®] AMMO PLANT

- Auto Progressive (AP[™]) Reloading Press
- Powder Measure & Case Activated Powder Drop
- Case Feeder
- Pistol Bullet Feeder

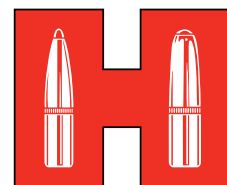
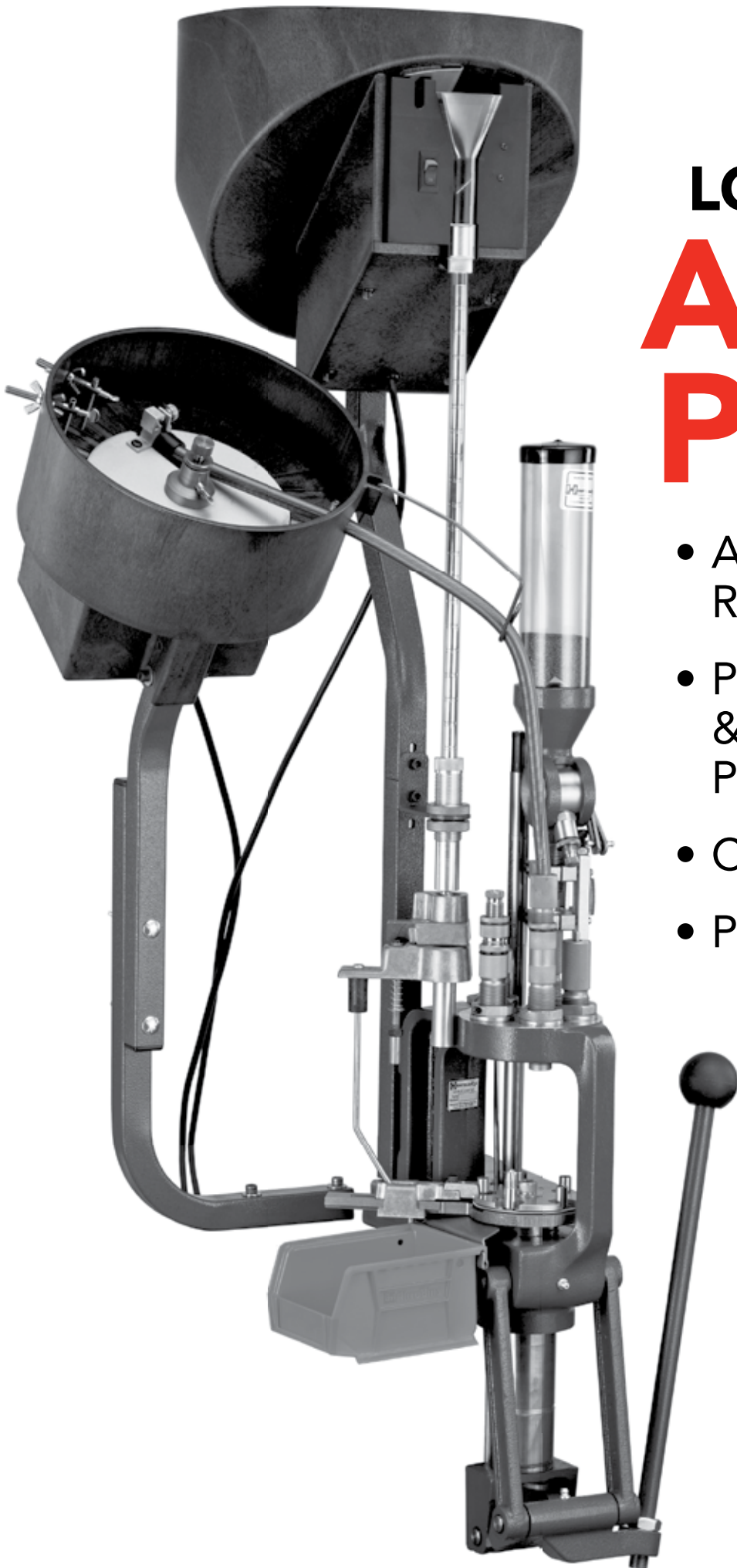

Hornady[®]
Accurate. Deadly. Dependable.

Items included with your **Lock-N-Load[®] Ammo Plant**

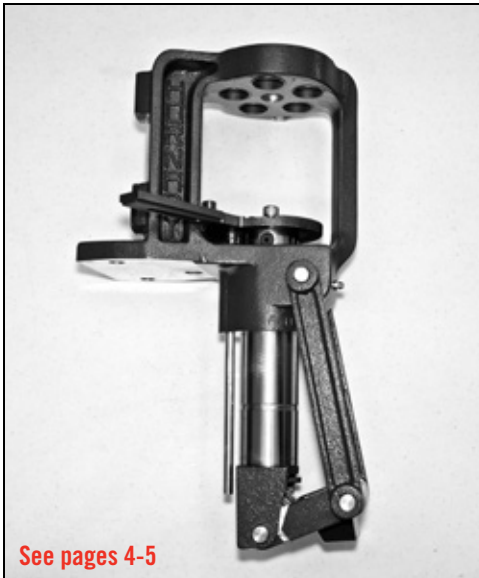

See pages 4-5



See pages 16-17

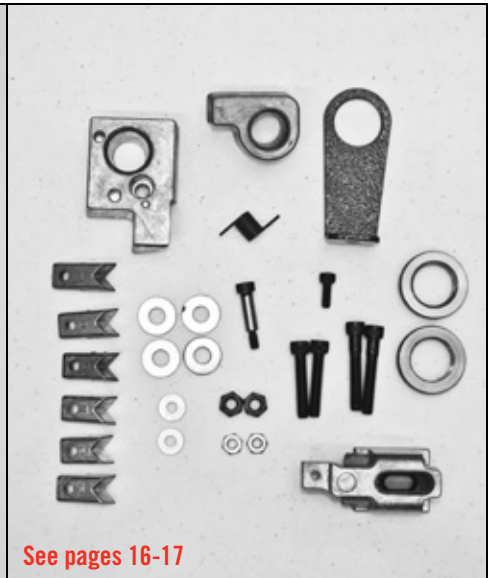

See pages 16-17



See pages 4-5



See pages 16-17



See pages 11-12



See pages 26-27

Table of Contents

ASSEMBLY

AP™ Press	Page 4
Powder Measure	Page 11
Case Feeder	Page 16
Pistol Bullet Feeder	Page 26

OPERATIONS	Page 34
-------------------------	----------------

CHANGE-OVERS

This section covers the selection and installation of the various components needed to change the Ammo Plant from one specific caliber to another.

AP™ Press	Page 38
Shell Plate	
Die Set	
Primer Components	
<i>Primer Slide</i>	
<i>Primer Tube</i>	
<i>Primer Punch</i>	

Powder Measure	Page 40
Changing Powder	
Metering Insert/Rotor	
Powder Sleeve/PTX Expander	

Case Feeder	Page 45
Feed Plate	
Feed Tube	
Pivot Adapter/Pivot Adapter Bushing	
Drop Tube	
V-Block	
Adjustments	
<i>Case Feed Door Adjustment</i>	

Pistol Bullet Feeder	Page 47
Plate Height	
Wiper Adjustment	
Drop Tube Funnel	
Drop Tube	
Bullet Feed Die	

TROUBLE SHOOTING

Lock-N-Load® AP™ Press	Page 50
Shell Plates	Page 50

APPENDIX

APPENDIX A	
Dies & Reloading Essentials Sizing Chart.....	Page 51

APPENDIX B	
Lock-N-Load® AP™ Press Mounting Template	Page 55

Lock-N-Load® Auto Progressive (AP™) Reloading Press

PARTS LIST

Item No.	Production Part No.	Qty.	Description
1	398318	1	Support Primer Tube
2	398356	1	Tube Primer Pickup, Large
3	398355	1	Tube Primer Pickup, Small
4	398358	1	Tube Primer, Large
5	398357	1	Tube Primer, Small
6	398322	1	Housing Tube Primer
7	392220	1	Screw, BHCS 1/4-20 X 1/2
8	392202	1	Lock-N-Load® AP™ Bracket
9	392342	1	SHCS SS 3/8-16 X 3/4
10	398359	1	Primer Follower
11	392338	1	Screw, SHCS 10-24 X 1/2
12			Shell Plate (Sold Separately)
14	398319A	1	Housing Body Primer Tube
15	392218	1	Primer Slide, Large Assembly
15	392219	1	Primer Slide, Small Assembly
16	392336	1	Spring Primer Slide
17	392363	1	Spring Case Retainer
18	398695	1	AP™ Breakaway Cam Wire
19	398698	1	Nut, 8-32
20	190216	1	Frame
21	392368	6	Clip C, C-50
22	480039	1	Box Catcher
23	392408	2	Lock-N-Load® AP™ Link
24	398309T	1	Sub Plate
25	398289	1	Bracket Box Catcher CF
26	398505	1	Primer Seater Punch, Small
26	398507	1	Primer Seater Punch, Large
27	392467	1	Spring Counter Balance

Item No.	Production Part No.	Qty.	Description
28	392345	1	3/8 Flat Washer SS
29	392355	1	Drive Hub
30	392356	1	Drive Shaft
31	392231	2	Screw, BHSCS 8-32 X 3/8
32	392344A	2	Pawl
33	392423	2	Spring Pawl
34	392306	2	Dowel Pin 1/8 X 1/2
35	392221	2	Screw, FHCS 1/4-28 X 3/8
36	290029	1	Spent Primer Tube
37	398163	1	Ram Assembly
38	398422	3	Grease Zerk™
39	392343	1	Toggle
40	392340	1	Pin Yoke
41	392424	5	Spring Washer
42	392417	2	Pin Link Toggle
43	390027	1	Nut Jam, 5/8-18
44	390657	1	Handle
45	480003	1	Knob
47	392358A	1	Index Wheel
48	390081	2	Clip E 1/2
49	392302	5	Lock-N-Load® Bushing, Male
50	392303	5	Lock-N-Load® Bushing O-Ring
51	392365	1	Spent Primer Tube, Plastic
52	392301	5	Lock-N-Load® Bushing, Female
54	398697	1	Breakaway Cam Plunger
55	398696	1	Breakaway Cam Wire Spring
	9987	1	DVD

No-Risk Lifetime Warranty

All Hornady reloading tools and accessories are warranted against material defects and workmanship for the life of the product. Simply stated – if it breaks, we'll repair it or replace it at no charge (at Hornady Manufacturing Company's option).

Hornady reloading tools and accessories are warranted against defective materials and workmanship only. This warranty is void if the product (1) has been damaged by accident or unreasonable use, neglect, improper service or other causes not arising out of defects in material or workmanship; or (2) has been altered or repairs have been made or attempted by other than authorized factory personnel; (3) is used commercially; or (4) has been altered or defaced in any way.

This warranty supersedes all other warranties for Hornady products either written or oral. No other warranty is expressed or implied.



Lock-N-Load® AP™ Reloading Press

EXPLODED VIEW

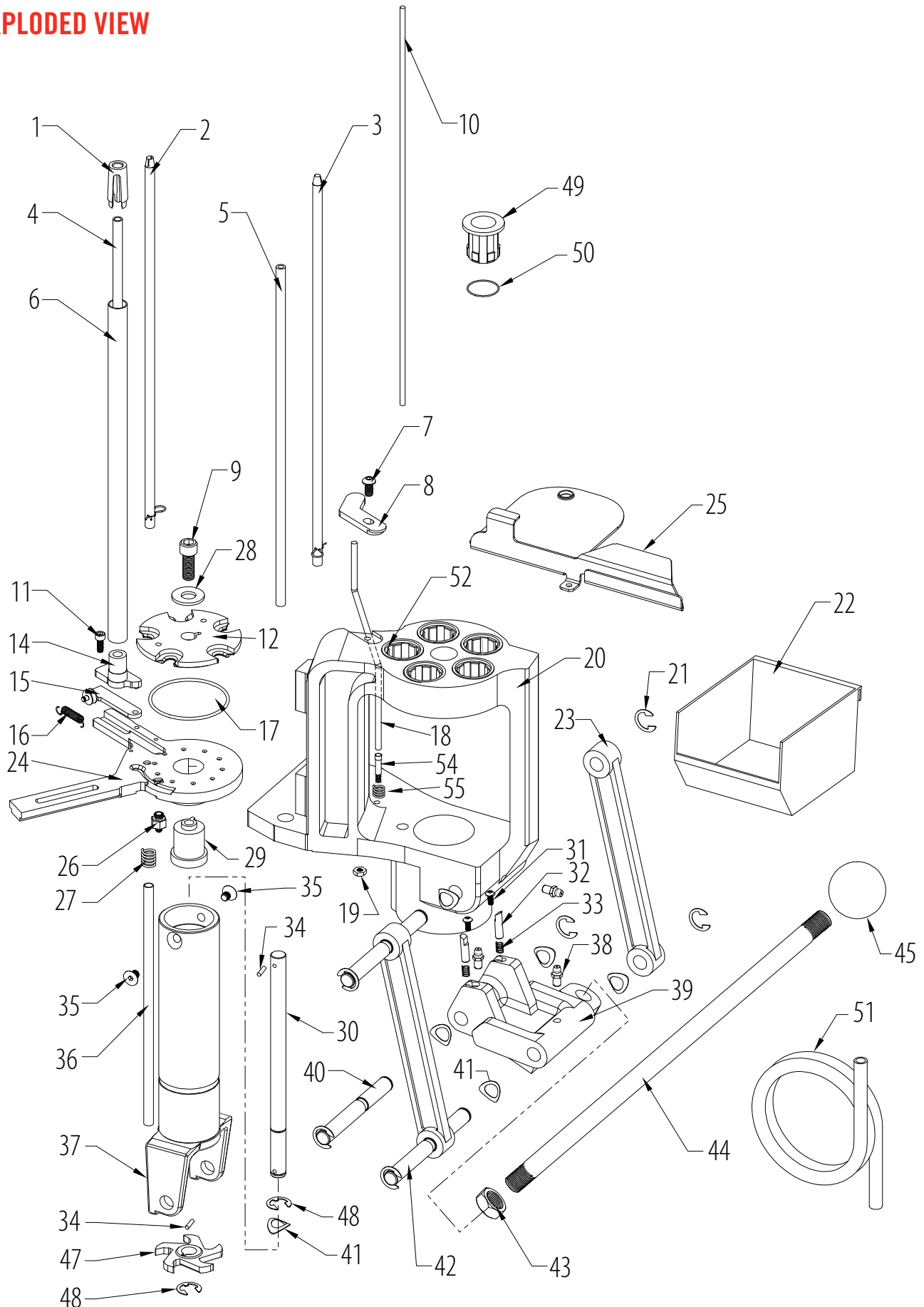

Lock-N-Load® AP™ Reloading Press

OVERVIEW

Your new Lock-N-Load® Auto Progressive (AP) Reloading Press has been packaged to insure minimal vibration and damage during transportation.

Remove all the parts from the packing box (see page 2) and spread them out over a large flat surface. **Refer to the Lock-N-Load® AP™ Reloading Press parts list and exploded view on the previous pages** and check to make sure all necessary parts are identified.

The manual provides step-by-step instructions and suggestions that make set-up and operation easy and understandable.

If at any time during operation you feel like you are forcing the press, stop and identify the problem. Do not force anything, or damage could occur. Powders and primers are explosive if handled carelessly! Always work slowly and carefully without distractions and wear eye protection. Try to avoid touching primers with oily fingers. The oil on your fingers may contaminate the primers and cause them to misfire.

Tools needed for assembly and set-up:

- 7/16" End Wrench
- (2) 1/2" End Wrenches
- 15/16" End Wrench
- 3/32" Hex Wrench (included)
- 1/8" Hex Wrench (included)
- 5/32" Hex Wrench
- Needle Nose Pliers
- Electric Drill
- 5/16" Hex Wrench

Hand loading is very safe, but before reloading any case please read the following warnings.

- Primers may explode if subjected to impact or heat.
- Keep away from the opening end of the Primer Tube at all times.
- Variations may occur with different brands and condition of cartridge cases, which can cause inconsistent primer and bullet seating. Sort and inspect all of your cases before reloading.
- Verify your powder charges at frequent intervals to insure consistency.
- Careless or improper hand loading techniques can result in serious personal injury. Make sure there are no distractions while you are reloading.
- Before operating this press, be sure you have read and understand all the instructions contained in this manual, and that you understand the principals of hand loading.



Mounting the Lock-N-Load® Auto Progressive

- 1 Your work area should be well lit and have plenty of room for your reloading accessories. Your Hornady Lock-N-Load® AP™ should be mounted securely 2 1/4" from the edge of a solid level bench and 3.75" apart and at least 16" from the nearest wall.

Use the template found on the last page and a hole punch to help locate each hole. (Check for obstructions on or below the bench before you drill any holes.)



- 2 Place cartridge catcher bracket under press, line up holes in press with holes in bracket. Insert and firmly tighten both bolts.

Mount the press using two 5/16" bolts that are long enough to secure the press to the bench with plenty of clearance for the nuts. (Due to variation of benches, these bolts are not provided.) We also recommend using 5/16" flat washers top and bottom, in addition to lock washers on the bottom side.

Insert and firmly tighten both bolts.

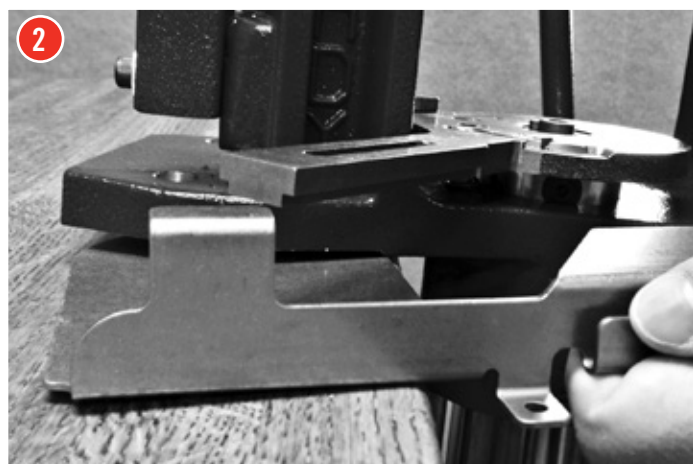

- 3 Thread the press Handle into the Toggle at the bottom of the press and tighten the Jam Nut using a 15/16" wrench.

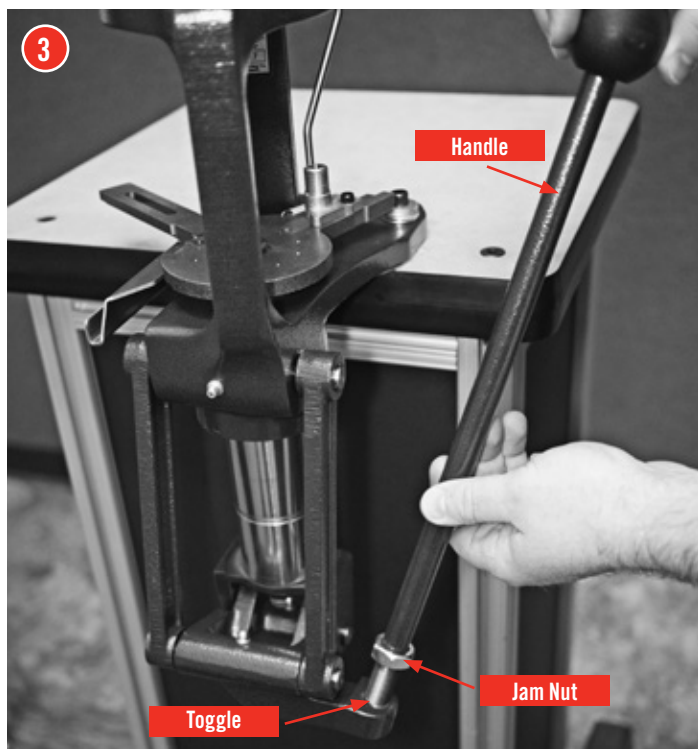

Determine which shell plate is required for your application

Refer to Appendix A to determine the correct shell plate.

4 Installing the Shell Plate

Put a small amount of general-purpose grease on the Shell Plate Ball Detents located on bottom side of Shell Plate, and on the top surface of the Sub-Plate.

Align the Shell Plate (12) with the keyed Drive Hub.

Place the 3/8" Shell Plate Retainer Bolt (9) through the 3/8" Flat Washer (28), (large end up) and thread the bolt into the Drive Hub (29).

Gently tighten the bolt using a 5/16" Allen wrench.

DO NOT over-tighten bolt, as it may damage Drive Hub or Pawls.

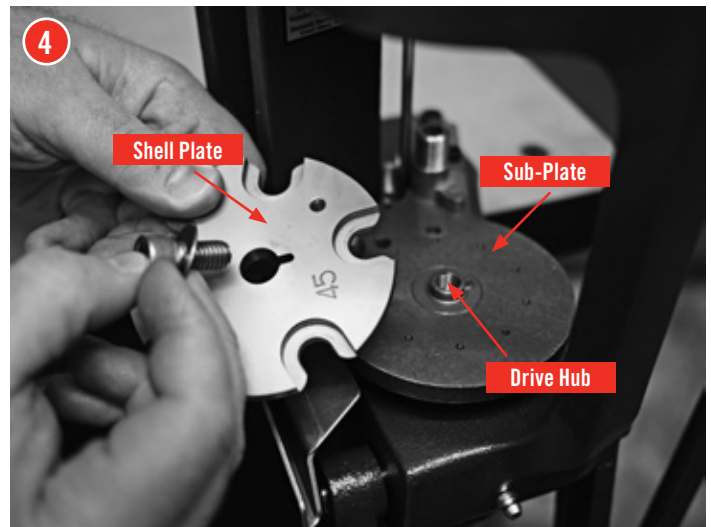

5 Stretch the Case Retainer Spring (17) around the Shell Plate (12).

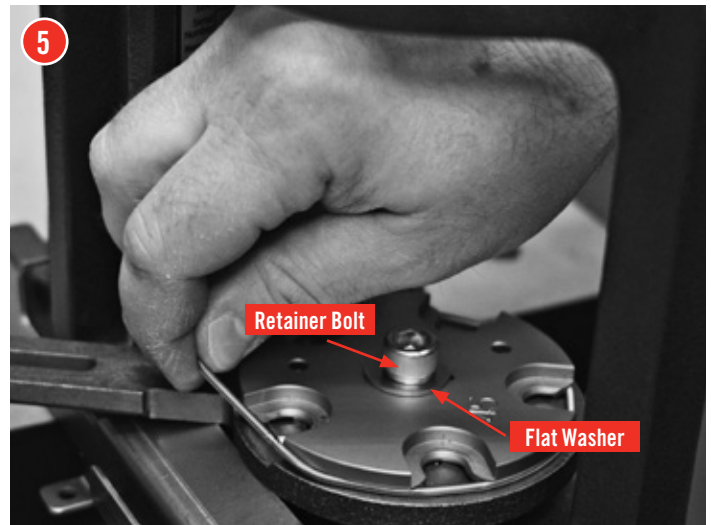

6 While cycling the Press, push the Case Retainer Spring into the relieved area on the Sub-Plate.

You will have to cycle the press a couple of stations to achieve these results.



Removing the Shell Plate

Use a 5/16" Allen wrench to remove the Bolt and shell plate. If the bolt is over tightened, use the Hornady Lock-N-Load® Deluxe Die Wrench (*Item No. 396495 sold separately*) to hold the shell plate while loosening the Bolt. This will prevent damage to the Drive Hub and/or Pawls.



Automatic Primer Feed Assembly

7 Installing the Primer Slide, Large or Small

Lower the handle.

Place the Primer Slide (15) flat side up in the groove on the Sub-Plate (24) and slide forward. *The bump on the bottom side of the slide is the travel stop as well as an alignment guide while the slide is in the retracted position.*

Attach the Spring to the Sub-Plate with the open end up (you may need to use needle nose pliers). Attach the other end of the Spring to the pin on the Primer Slide.

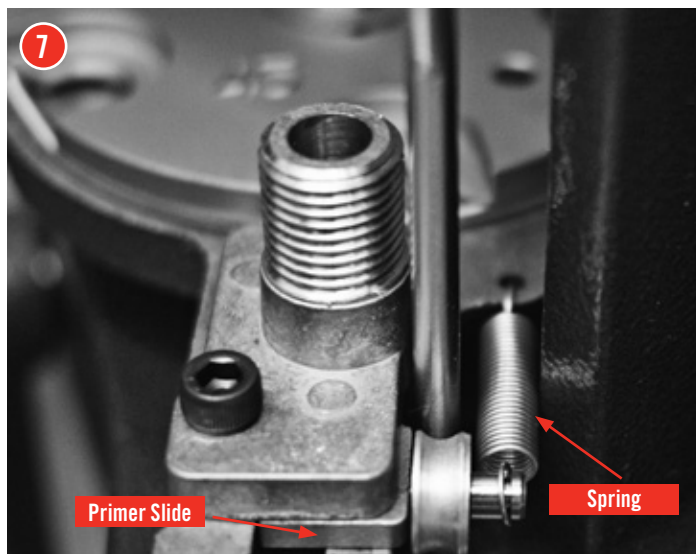

8 Installing the Primer Punch Assembly, Large or Small

Raise the Ram to the top of the stroke.

Screw the Primer Seater Punch (26) into the Sub-Plate from the bottom side.

Tighten the Primer Seater Punch assembly until it is snug using a wrench. (Do not over-tighten the Primer Punch).

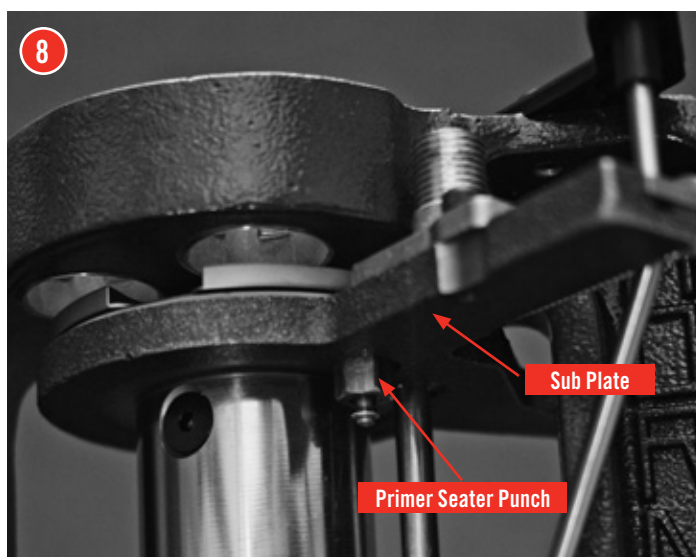

9 Installing the Primer Tubes

Place the tube of your choice (large or small primers) in the center hole of the Primer Body with the shoulder section of the tube facing down. Make sure the tube is fully seated in the Primer Body (14).

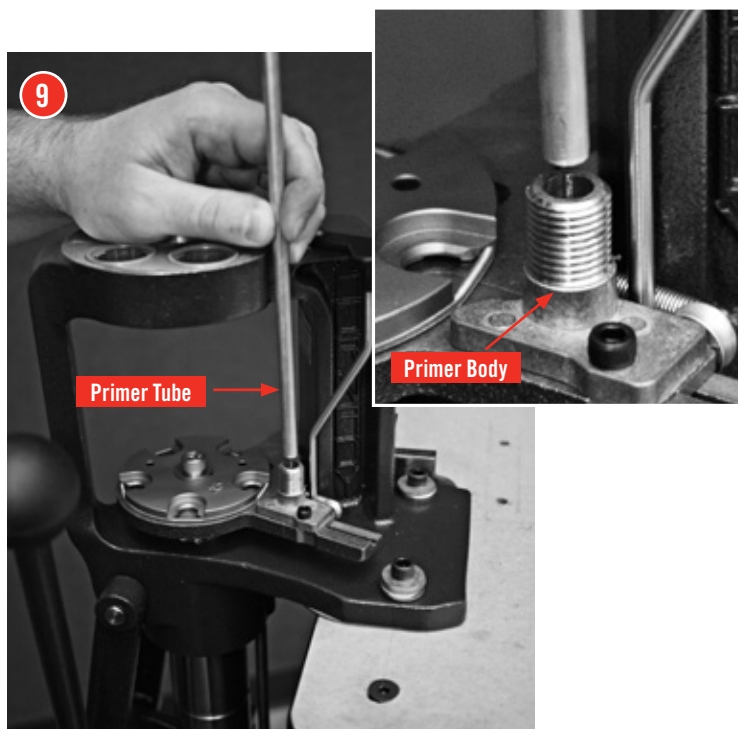

10 Installing the Primer Tube Housing

Slip the threaded end of the Primer Tube Housing (6) over the Primer tube and onto the Primer Body.

Screw the Primer Tube Housing on to the Primer Body (14) clockwise: tighten very lightly. Lower the handle.

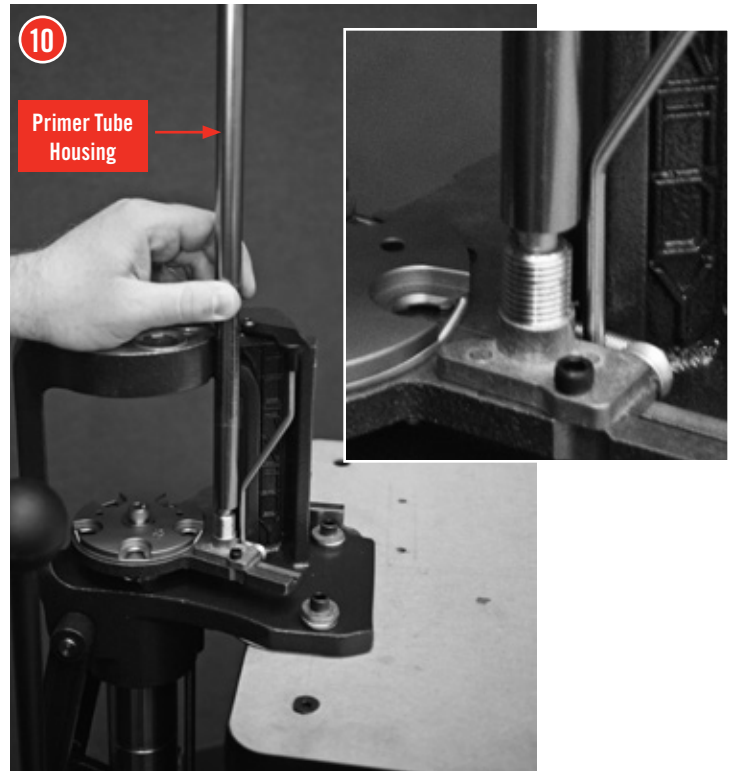

11 Primer Tube Support installation

Place the Primer Tube Support (1) over the Primer Feed Tube and slip the three tapered “fingers” inside the Primer Tube Housing. This will create a recess that allows the Primer Filler Tube to properly align with the Primer Feed tube during refillings.

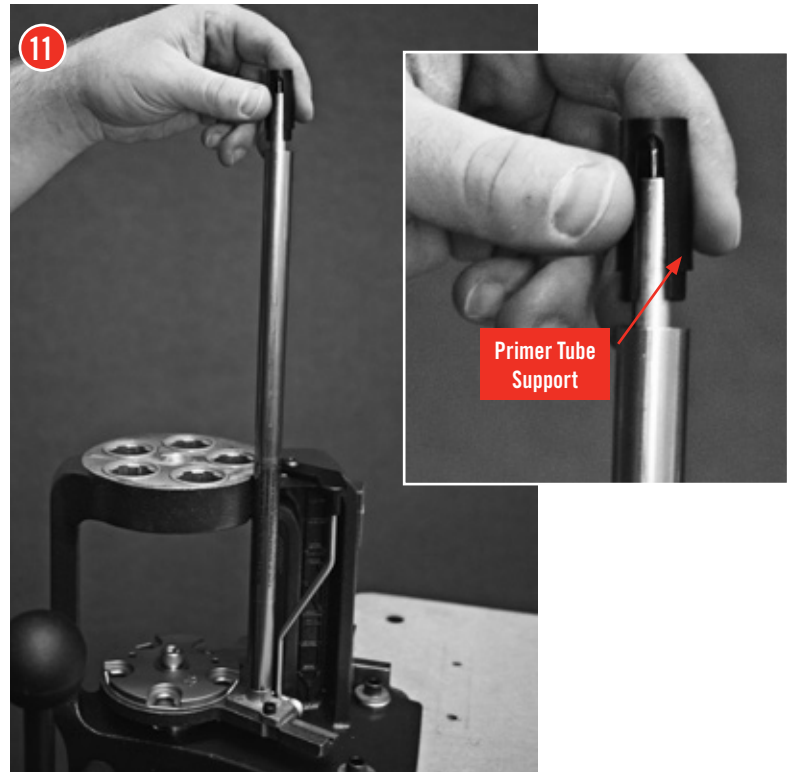

Assembly of the Lock-N-Load® AP™ Press is now complete. Please proceed to the Powder Measure assembly section on the next page.

Lock-N-Load® Powder Measure

PARTS LIST

Item No.	Production Part Number	Qty.	Description
1	170405	1	HOPPER CAP
2	398520	1	HOPPER
3	392740	1	BODY
4	392719	2	SCREW BHSCS 10-32 X 3/8
5	392752	1	HANDLE ASSEMBLY
6	392741	1	ROTOR
7	392743	1	METERING PLUNGER
8	392742	1	SLEEVE
9	480083	1	O-RING 1/2 ID X 1 11/16 OD
10	392764	1	NUT LOCK METERING UNIT
11	392766	1	O-RING 1 1/2 ID X 1 5/8 OD
12	390702	1	SMALL DROP TUBE
13	390701	1	LARGE DROP TUBE
14	392760	1	MOUNTING BRACKET
15	390656	1	3/32" HEX WRENCH
16	044000	1	LOCK RING
17	390653	1	1/8" HEX WRENCH

EXPLODED VIEW

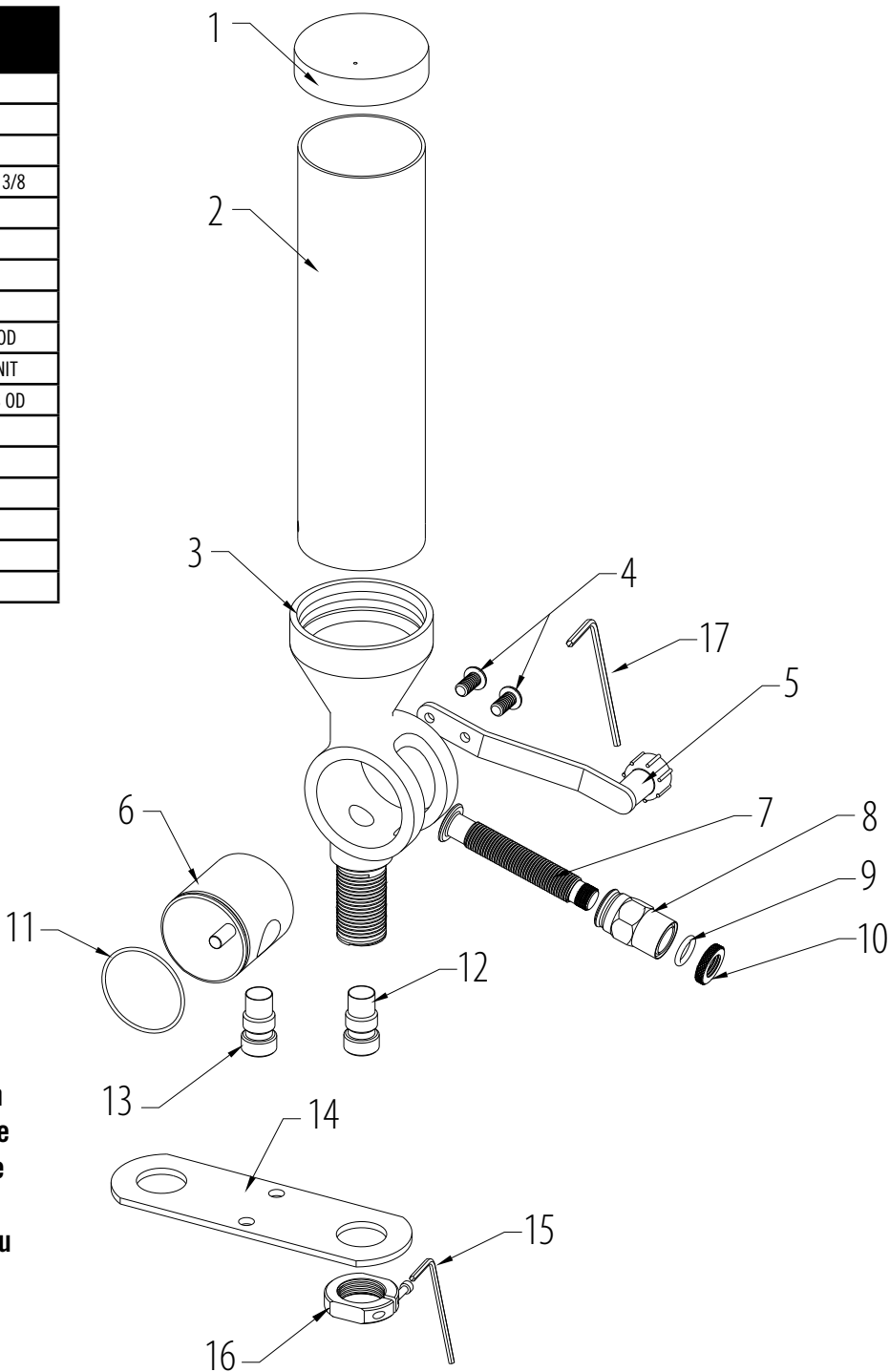

Precautions for the Powder Measure:

- Always change the metering units with the handle and the metering unit in the horizontal position, and after you have dropped the charge. If you allow the Handle to fall while changing units, you will drain the Hopper.
- Be sure that you have the proper Lock-N-Load® device locked in place, before operating.
- Always verify your charges with a scale before loading.
- Any moisture in the unit will cause powder to stick, and charge weights will vary dramatically.

Lock-N-Load® Case Activated Powder Drop

PARTS LIST

EXPLODED VIEW

Item No.	Production Part Number	Qty.	Description
1	392721	2	BHSCS 10-32 X 1.00
2	392708	2	MOUNTING CLAMP
3	392710	1	ROTOR ARM
4	392719	5	BHSCS 10-32 X 3/8
5	392715	2	SHOULDER NUT
6	398735	1	PIVOT
7	398737	1	DRIVE LINK
8	398736	1	MEASURE LINK
9	398742	2	BHSCS 10-32 X 1.25
10	392717	1	GROOVE PIN 3/16 X 7/8
11	392718	1	SPRING PIN 1/8 X 3/8
12	392707	1	UPPER BRACKET
13	398739	2	SPRING NUT
14	398738	1	RETURN SPRING
15	392705	1	DROP TUBE
16*	392703	1	17 CAL. SLEEVE
17	392701	1	#1 POWDER SLEEVE
18	392702	1	#2 POWDER SLEEVE
19	392700	1	PISTOL POWDER SLEEVE
20*	290030	1	.355 POWDER THRU EXPANDER
20*	290031	1	.357 POWDER THRU EXPANDER
20*	290032	1	.400 POWDER THRU EXPANDER
20*	290033	1	.430 POWDER THRU EXPANDER
20*	290034	1	.451 POWDER THRU EXPANDER
20*	290035	1	.452 POWDER THRU EXPANDER
20*	290037	1	.475 POWDER THRU EXPANDER
20*	290038	1	.500 POWDER THRU EXPANDER
21	392704	1	MEASURE ADAPTER
22	392706	1	LOWER BRACKET
23	398741	1	LOCKING BOLT
24	392722	1	RETAINING RING
25	044000	1	LOCK RING
26	392302	1	LOCK-N-LOAD® BUSHING

* (Sold Separately)

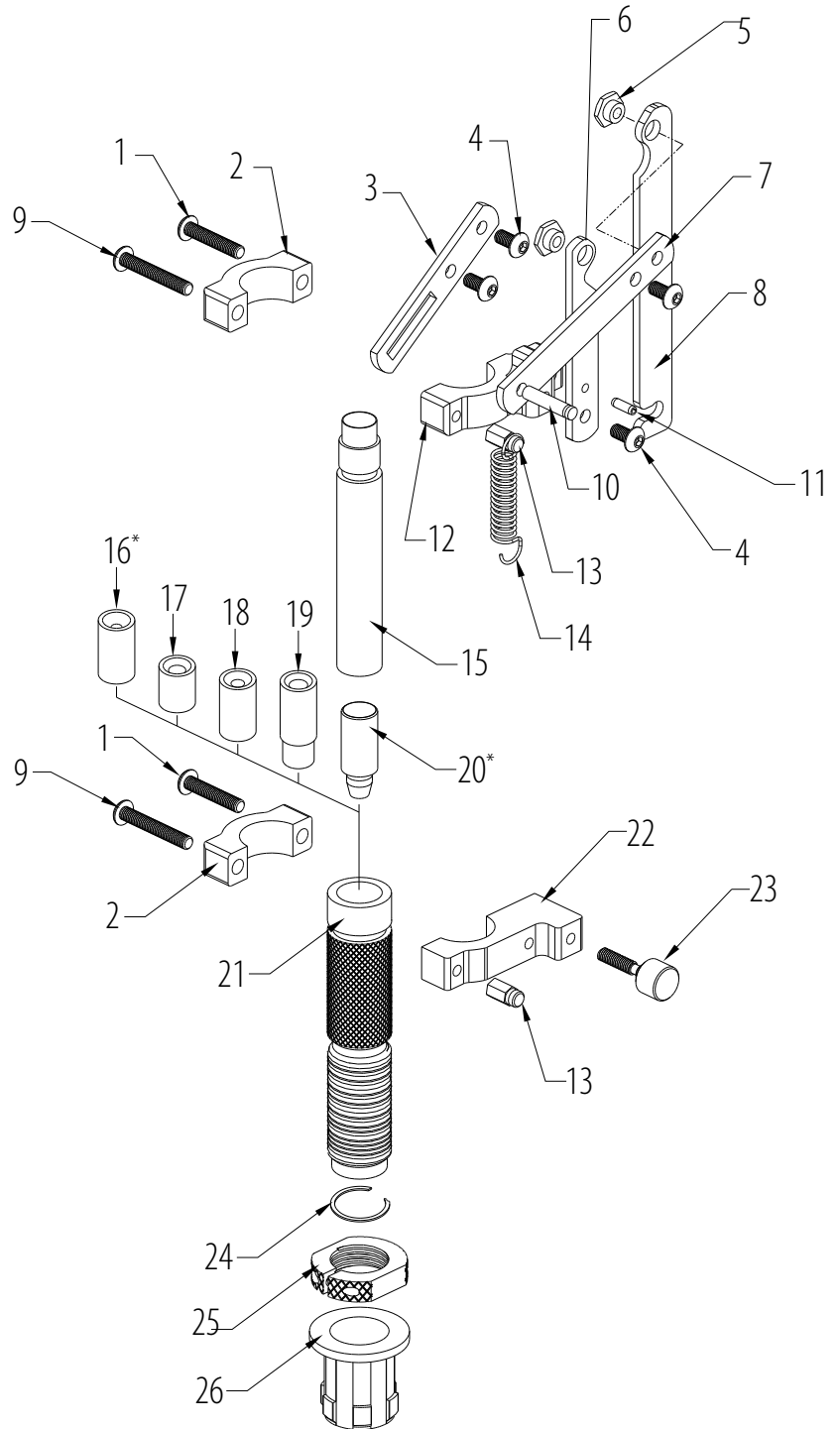

Assembly of Lock-N-Load® Case Activated Powder Drop

The Case Activated Powder Drop helps make reloading faster and easier than ever before. It automatically activates and dispenses a charge with every pull of the handle, but only when a case is present in the station. Plus, it works with Lock-N-Load® Bushings. *(You can remove and change Hornady® powder measures with a quick turn, without changing adjustments.)* The Case Activated Powder Drop unit can be used ONLY on the Hornady® Lock-N-Load® Powder Measure.

The Lock-N-Load® Powder Measure comes with the Standard Rotor and Standard Metering Insert installed, with the Pistol Rotor and Pistol Metering Insert packaged separately.

Your Lock-N-Load® Powder Measure has been treated with a rust preventative that must be removed prior to use. We recommend that you clean and degrease all metal parts with Hornady® One Shot® Cleaner and Dry Lube.

To Disassemble for Cleaning:

- 1 Set the Rotor with the Metering Unit perpendicular to the axis of the Body, press the Push Button and hold it down while removing the Metering Unit.

NOTE: Do NOT remove push button. It is permanently installed and does not need cleaning.

- 2 Unscrew the Drop Tube (15) from the bottom of the Powder Measure.

Remove the Handle, or Rotating Arm from the Powder Measure, by removing the two attaching screws with a 1/8" hex wrench.

- 3 Slide the Rotor out of the Body by pressing gently on the handle side of the Rotor.

NOTE: Be careful not to drop or otherwise damage the Rotor while it is out of the Body.

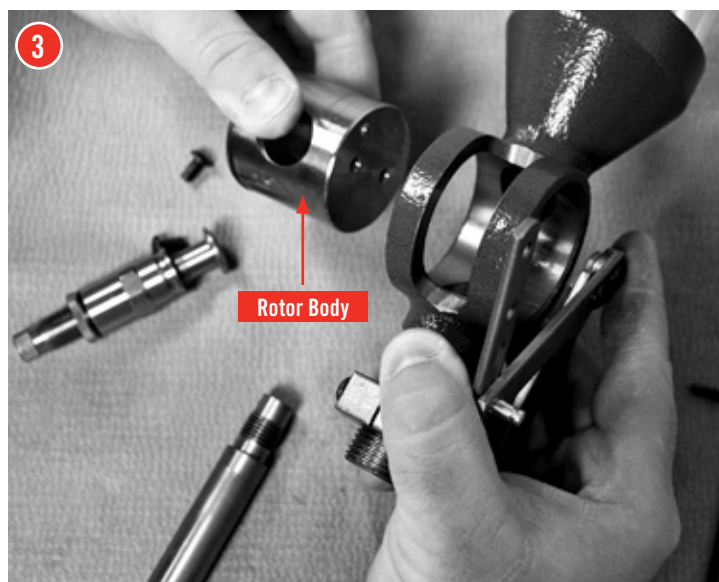
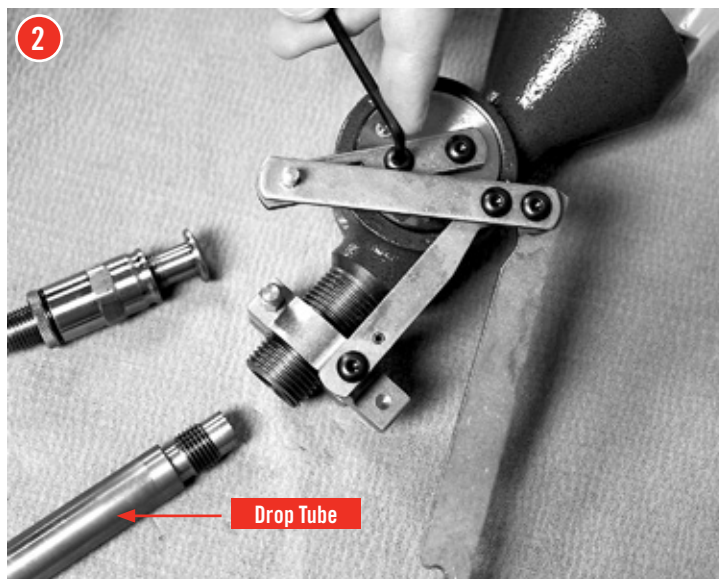

- 4 Remove the Lock Nut, O-Ring and Sleeve from the Metering Plunger.

Spray all metal parts liberally with Hornady® One Shot® Gun Cleaner and Dry Lube. Be sure all rust preventative has been removed.

Allow it to dry thoroughly before reassembling.

To Re-Assemble After Cleaning:

- 5 Reverse the procedure in the first five steps above.

Due to the tight machining tolerances of the Rotor and Body, they must be properly aligned to reassemble.

DO NOT FORCE IT OR PERMANENT DAMAGE WILL OCCUR.

Installing the Case Activated Powder Drop (Lower Assembly)

- 6 Screw the Measure Adapter (21) (Lower Assembly) onto the Lock-N-Load® Bushing several turns. Place lower Assembly into top of press and rotate to lock into the Lock-N-Load® Bushing.
- 7 Select the appropriate powder bushing sleeve for your application (**Refer to Chart on page 45**). Insert the bushing, with the deep counter sink facing up, into the top of the measure adapter.

If using a Powder Thru Expander Sleeve (PTX Sleeve), insert the PTX Sleeve with the deep countersink facing up, into the top of the Measure Adapter.

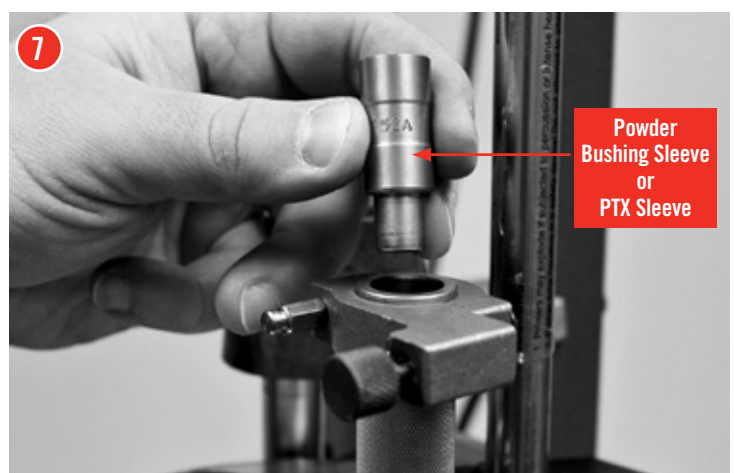
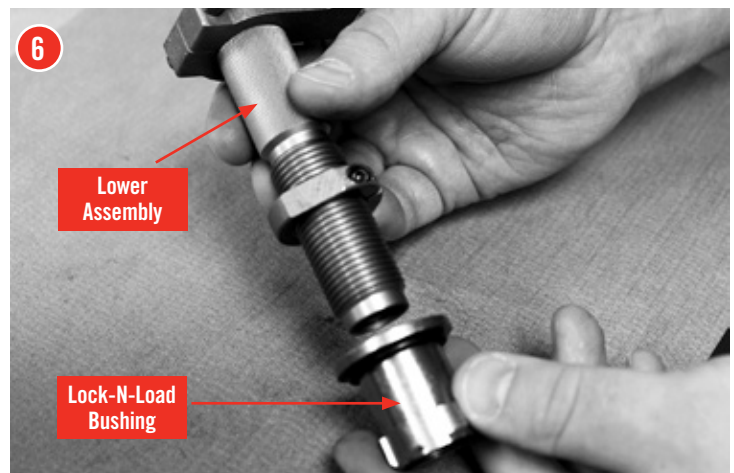
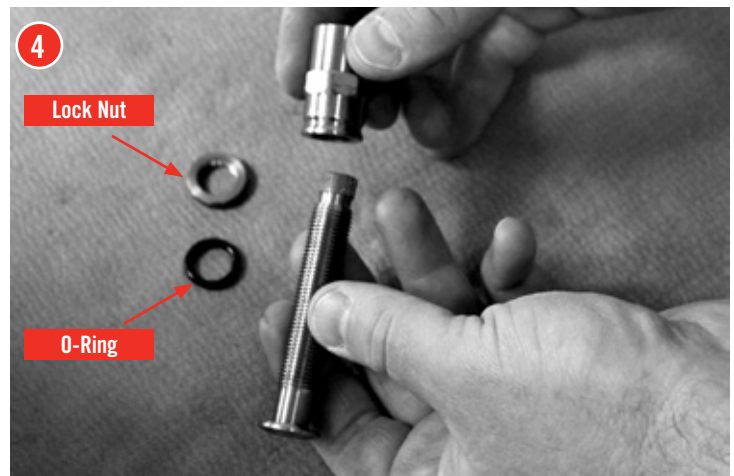

Final Powder Measure Assembly

- 8** Insert the Powder Drop Tube into the lower assembly
Connect the Link (8) to Lower Assembly by sliding the Link over the Thumb Screw (23).
Tighten the Thumb Screw.

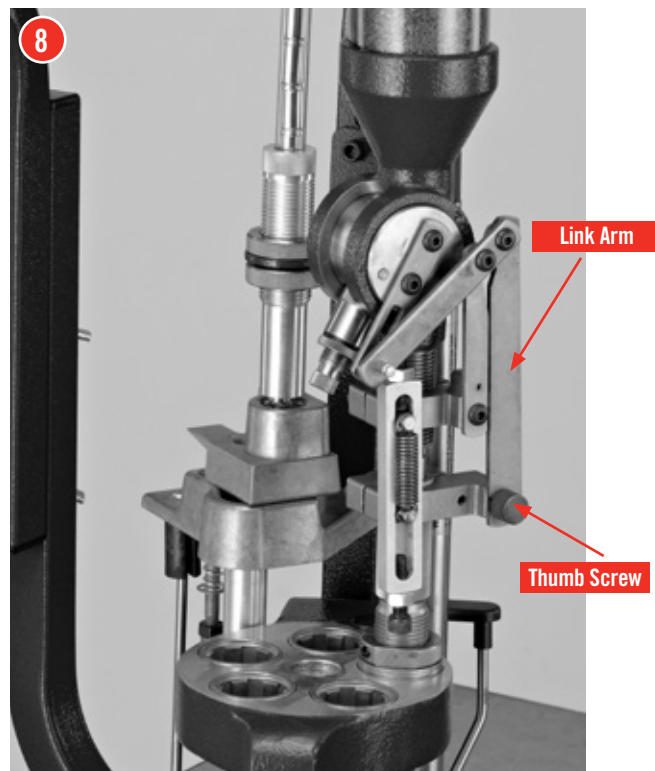

- 9** Attach PTX Powder Measure Stop.
Attach Spring (14).
(For adjustment, refer to Chart on page 43).

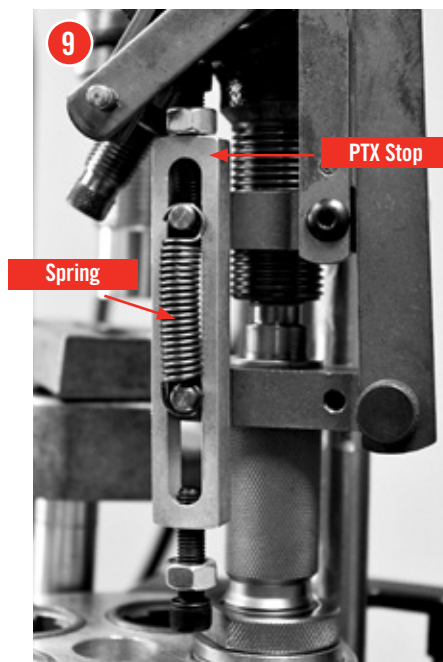

- 10** Drop Baffle into Powder Hopper to prevent powder bridging and help produce consistent charges.

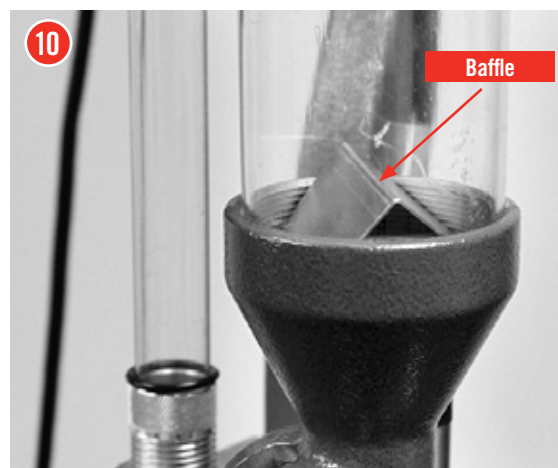

Lock-N-Load® Auto Progressive (AP™) Case Feeder

PARTS LIST

Item No.	Production Part No.	Qty.	Description
1	398441	1	Case Feed Bowl
2	398313	4	10-32 x ¾ FHSCS
4	398445	4	8-32 x 3/4 Screw
5	398443	1	Case Feed Funnel Front
6	398375	2	4-40 Hex Head Lock Nut
7	399364	1	Micro Switch
8	398442	1	Case Feed Funnel Back
9	398376	2	4-40 x 5/8 BHSCS
10	398332	1	Rocker Switch
11	398331	1	Motor
12	398444	1	Motor Cover
13	398320	1	Feed Tube - Large
14	398321	1	Feed Tube - Small
15	398303	1	Feed Tube End Primary
16	398446	1	Feed Tube Mounting Bracket
17	396440	2	Lock Ring
18	398298	1	Pivot Adapter
19	398290	1	Pivot
20	398310	1	1/4 - 3/4 Shoulder Bolt
21	398311	1	3/0 x 3/4 Taper Pin
22	398305	1	Drop Tube - Large
23	398288	1	Spring, Torsion
24	398317	1	Push Rod
25	398371	1	Push Rod Tip
26	390178	4	1/4-20 Hex Head Nut
27	398349	1	Push Rod Bushing
28	398364	1	10 x 1/2 Sheet Metal Screw Pan Head Phillips
29	398344	1	Pivot Body
30	398363	1	Push Rod Spring
31	398343	1	Cam Wire Support
32	398425	1	E Clip 1/4
34	398372	1	Push Rod Lower
37	398285	1	Case Feed Door Adjustment
38	398291	1	Case Slide
39	398307	1	Case Slide Rod Guide

Item No.	Production Part No.	Qty.	Description
40	398308	1	Case Slide Rod Guide Spring
41	392011	2	10-32 Hex Head Nut
42	398289	1	Main Bracket
43	398299	1	Cam Wire
47	398321	2	1/4-20 x 125 SHCS
48	390128	5	1/4 Flat Washer Zinc Plated
49	392031	2	1/4" Lock Washer
50	398360	1	Feed Tube Insert - Small
51	398300	1	Pivot Adapter Bushing
52	398301	1	Pivot Bushing
53	398306	1	Drop Tube-Small
54	095310	*	Case Feed Plate - Small Pistol
55	095312	*	Case Feed Plate - Large Pistol
56	095314	*	Case Feed Plate - Small Rifle
57	095316	*	Case Feed Plate - Large Rifle
58	059100	*	AP Press
59	398346	1	10-24 x 1/2 SHCS
60	398293	1	V-Block #1
61	398297	1	V-Block #2
62	398294	1	V-Block #3
63	398292	1	V-Block #4
64	398295	1	V-Block #5
65	398296	1	V-Block #6
66	398324	1	Plastic Feed Tube Small Bushing
67	390651	2	3/16" Flat Washer SAE
68	390410	1	10-24 x 1/4 BHCS
69	398370	1	Case Feed Bowl Bushing
70	398388	3	1/4-20 x 150 SHCS
71	398416	1	O-Ring 7/8 OD, 11/16 ID
73	398361	1	Feed Tube Insert - Intermediate
74	398447	1	Case Feeder Stand 2-PC Upper
75	398449	1	1" Square Tube Connector
76	398448	1	Case Feeder Stand 2-PC Lower

* Optional Accessories: Sold Separately

Lock-N-Load® AP™ Case Feeder

OVERVIEW

Your new AP™ Case Feeder has been packaged to insure minimal vibration and damage during transportation.

Remove all the parts from the packing box (see page 2) and spread them out over a large flat surface. **Refer to the Lock-N-Load® Case Feeder parts list and exploded view on the previous pages** to make sure all necessary parts are identified.

The manual provides step-by-step instructions and suggestions that make set-up and operation easy and understandable.

NOTE: *Everything is designed and machined to fit easily together without modification. If you find that it is necessary to force parts together, stop and check the instructions and illustrations we have provided.*

List of needed hand tools:

- 3/8" wrench
- 7/16" wrench
- 9/16" wrench
- 1/8" Allen wrench
- 5/32" Allen wrench
- 3/16" Allen wrench
- Pliers or vise grips
- Small hammer

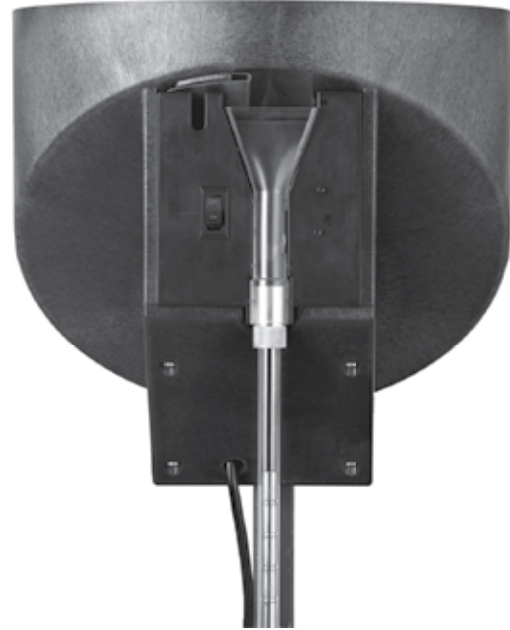

Assembling the 2-pc Square Tubing.

1 Place Lower Case Feeder Stand next to mounting holes on the back of the AP™ press to determine proper orientation of the Lower Case Feeder Stand. Once the “top” of the Lower Case Feeder Stand has been determined, place the Lower Case Feeder Stand onto a block of scrap wood. Next insert the Tube Connector into the Lower Case Feeder Stand until the holes align. Place the Feed Tube Mounting Bracket onto the Lower Case Feeder Stand so the Feed Tube Mounting bracket is on the open end of the Tube Connector (see photo). Place a ¼-20 x 1.5" bolt through the Feed Tube Mounting bracket and Lower Case Feeder Stand and loosely attach the flat washer, lock washer, and nut.

Place Upper Case Feeder Stand over the Tube Connector until it touches the Lower Case Feeder Stand. Place a ¼-20 x 1.5" bolt through the Feed Tube Mounting bracket and Upper Case Feeder Stand and securely attach the flat washer, lock washer, and nut. Tighten the lower nut in the Lower Case Feeder Stand.

Attach assembly onto AP™ Press.

CORRECT ASSEMBLY

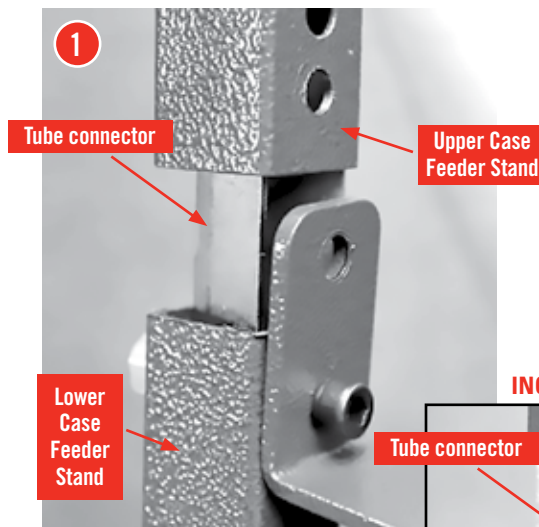

INCORRECT ASSEMBLY

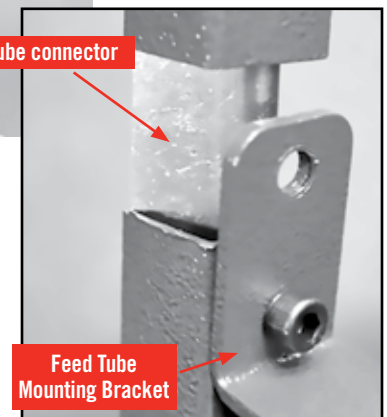

Attaching the Square Tubing to the frame of the AP™ Press.

2 Place the ¼" Flat Washers (48) on the ¼-20 x 1 ¼" Socket Head Cap Screw (SHCS) (47).

Place one SHCS through the Square Tubing (76) and thread into the Frame.

Repeat for the second Screw.

Tighten both screws down using a 3/16" Allen wrench.

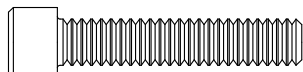

¼-20 1 ¼" Cap Screw (Full Size)

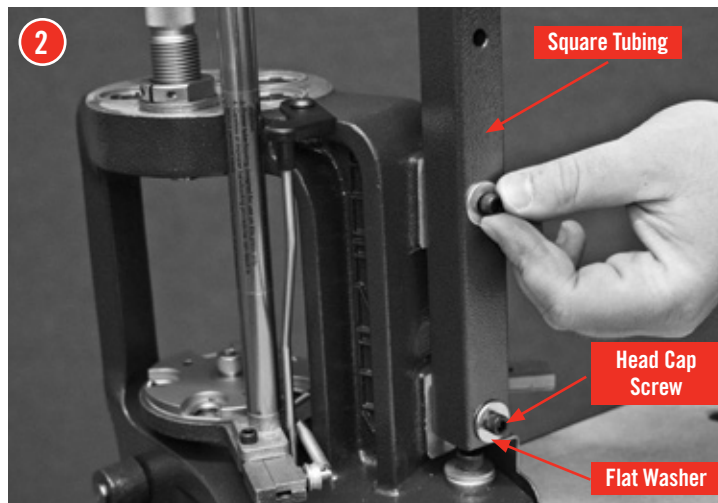

Adding the Case Slide on to the Sub-Plate

3 Assemble the Case Slide by placing the Spring (40) in the relief of the Slide and hooking the relief of the Guide (39) onto the end of the Spring. Slide the Guide forward and compress the Spring until the Guide fits into the pocket. You may need to hold the Guide and Spring into the Slide with your finger as you slide the assembly back onto the "Sub-Plate."

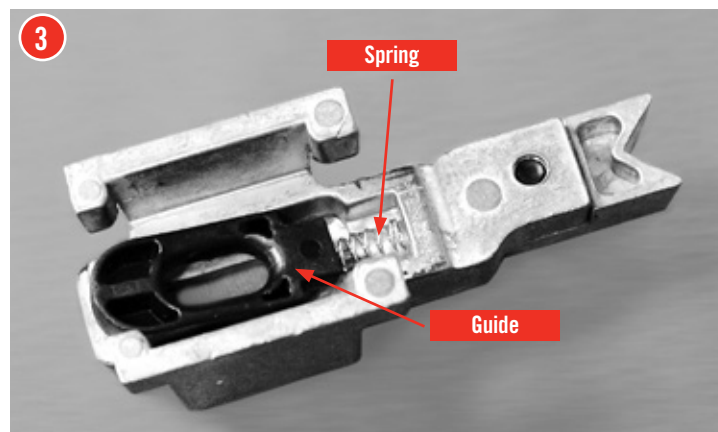

Inserting the Cam Wire into the Assembly.

4 Raise the Ram to the top of the stroke.

Screw one #10-32 Hex Nut (41) onto the Cam Wire (43) approximately 1" from the end.

Place one of the #10 Flat Washers (67) onto the Cam Wire.

From the bottom of the Sub-Plate, slide the non-threaded end of the Cam Wire through the slot of the Sub-Plate and through the Case Slide (38).

Place the threaded end of the Cam Wire through the hole of the tab on the Main Bracket.

Place the other Flat Washer and Hex Nut onto the bottom of the Cam Wire and tighten finger tight.

Lower the Ram.

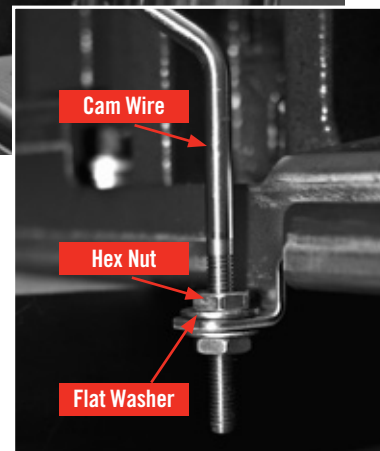
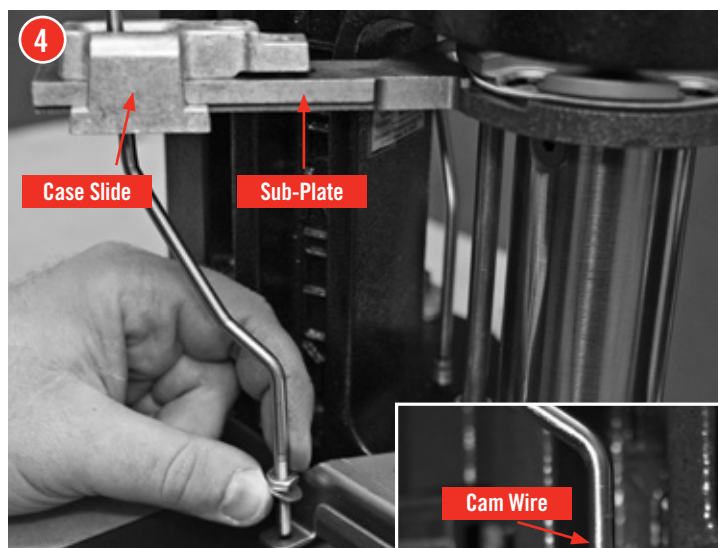

Case Escapement Bracket Assembly.

- 5** Put a ¼" Flat Washer on the ¼-20 X 1 ½" Cap Screw (70).
Place the Cap Screw through the Square Tubing and thread the Hex Nut the length of the nut.



¼-20 x 1 ½" Cap Screw (Full Size)

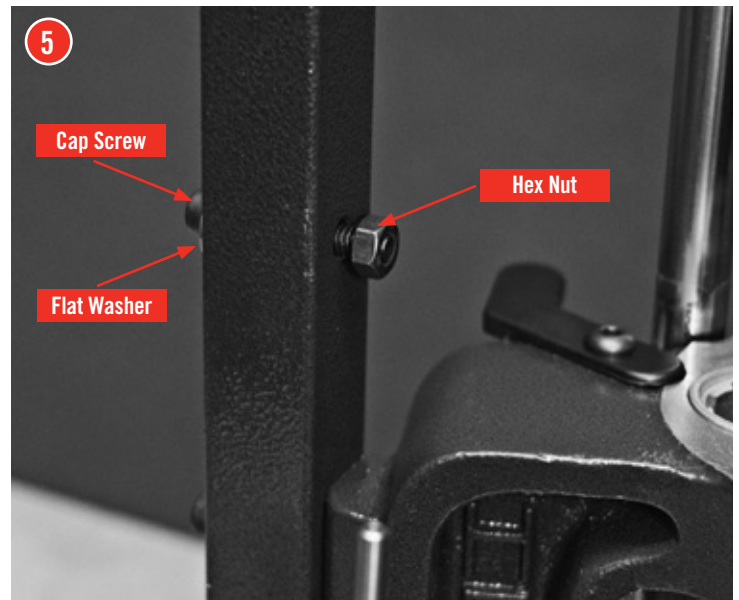

- 6** Slip the Pivot Block (29) over the Cap Screw (70) so the Hex Nut is in the slot on the back of the Case Escapement Body.
Slip the Cam Wire (43) into the Cam Wire Support (31).
Tighten the Cap Screw while holding the Bracket level with the top of the frame.

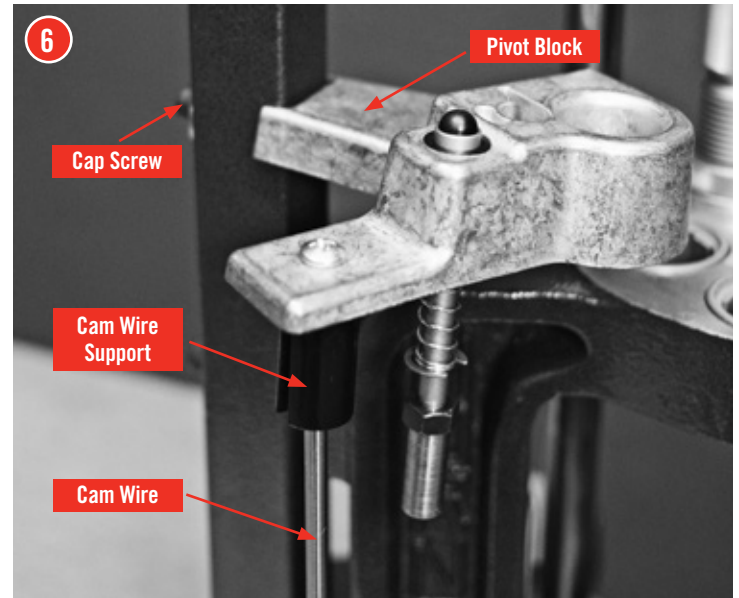

Feed Tube Mounting Bracket.

- 7** Slide the 1" Square Tube Connector (75) into the tubing (76) with the open end of the V forward until the bottom hole lines up with the uppermost hole in the tubing. Orient the Feed Tube Mounting Bracket (16) as shown in the exploded view. Place a ¼-20 x 1.50 SHCS (70) through the bottom hole, then through the square tubing. Place a ¼ Flat Washer (48) and ¼ Lock Washer (49) over the screw, and lightly thread on a ¼-20 Hex Head Nut (26).

Slide the Case Feeder Stand 2-PC Upper tube (74) over the Square Tube Connector (oriented as shown in the exploded view) until the two holes line up. Place a ¼-20 SHCS through the remaining hole in the Feed Tube Mounting Bracket and through the square tubing. Place a ¼ Flat Washer and ¼ Lock Washer over the screw, and thread on a ¼-20 Hex Head Nut. Tighten both Hex Head Nuts until snug.



¼-20 x 1 ½" Cap Screw (Full Size)

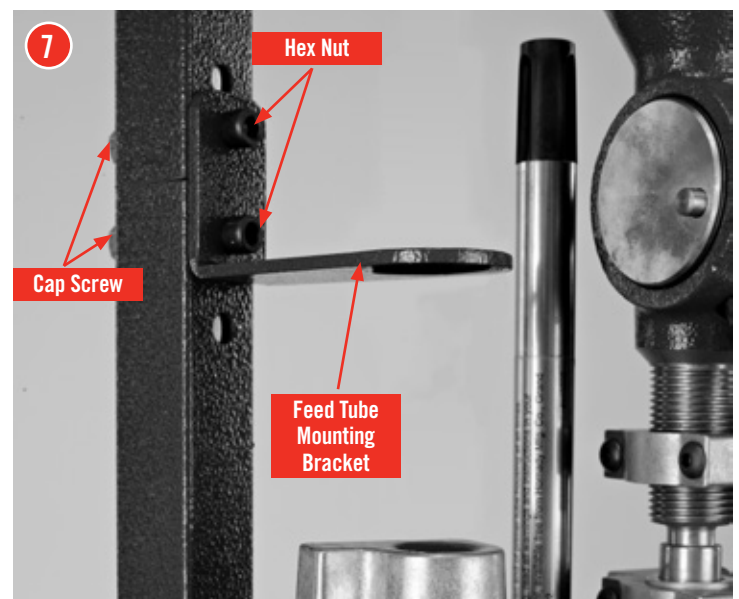

Installing the V-Block onto the case slide.

- 8 With the Ram at the bottom of the stroke (idle position), set the V-Block onto the Case Slide (38).

Refer to chart on page 45 for proper V-Block.

Place the #10-24 X 1/2 Cap Screw (59) through the hole of the V-Block and screw it into the Case Slide. Before you tighten the Cap Screw, push the V-Block back into the Case Slide and snug the Cap Screw with your fingers.

*The proper adjustments of the cam wire will be discussed later on **Change-Over: Case Feeder Page 46.***

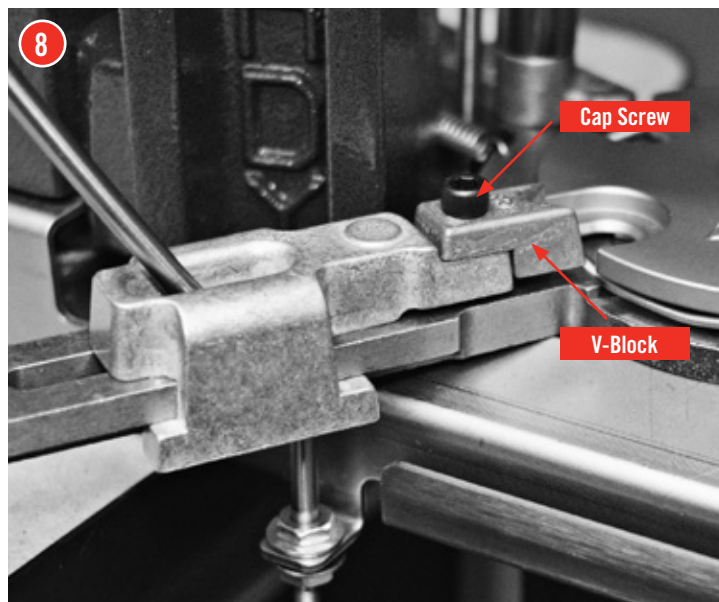

Assembling the Feed Tube End and Pivot.

- 9 If the maximum case diameter is larger than .43" you will need to use the large Drop Tube. If it is smaller, you will need the small Drop Tube. Place the correct one into the Pivot Block.

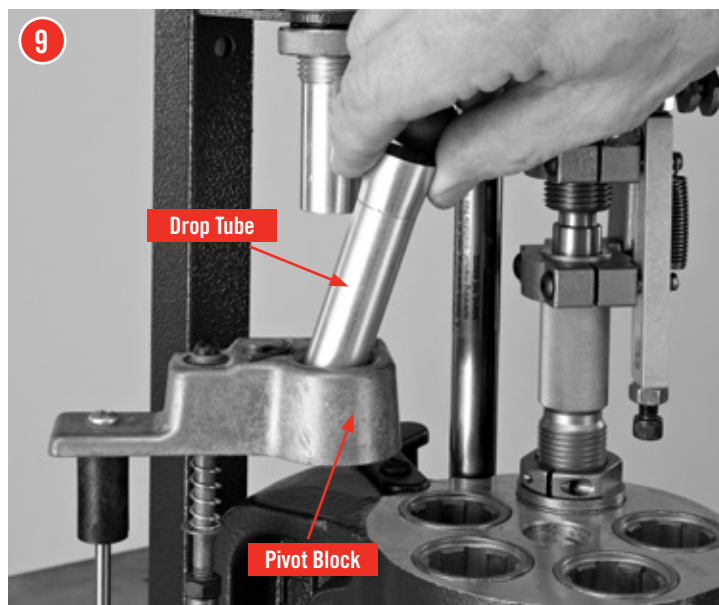

- 10 Place the Torsion Spring (23) into the slot in the Pivot Block (29), leaving the long leg on the top side. The Spring will only fit one way.

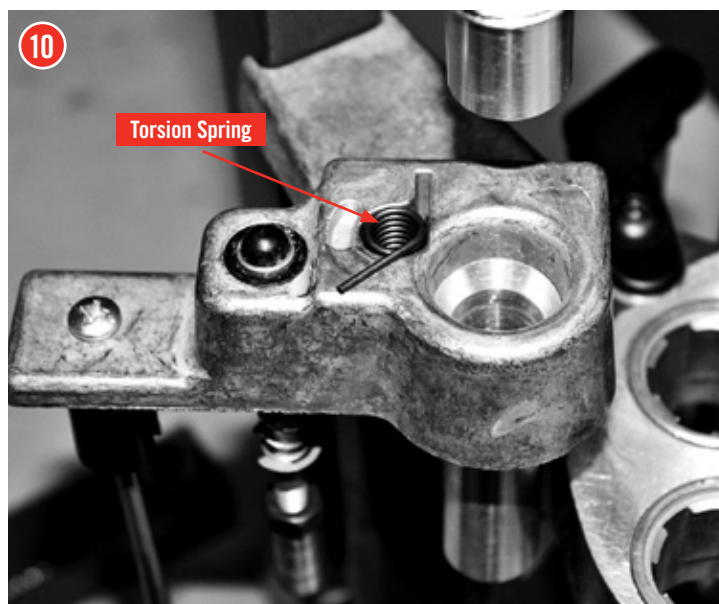

Assembling the Feed Tube End and Pivot (con't).

- 11** Set the Pivot (19) on top of the Pivot Block (29). Make sure you line up the under cut in the bottom of the pivot with the Torsion Spring (23). The leg of the Torsion Spring will fit into the slot on the Pivot.

When this fits together, the Pivot should fit on top of the Pivot Block. The Dowel Pin (21) in the Pivot will fit into the curved slot on the Pivot Block (29).

Then insert the Shoulder Bolt (20) into the pivot and into the pivot block and tighten with an Allen wrench.

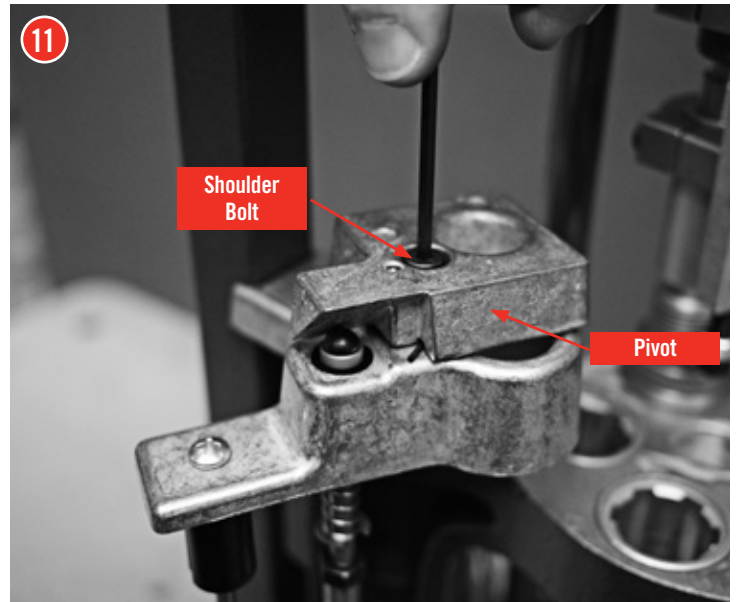

- 12** Actuate the Pivot by hand to make sure it will rotate smoothly and spring return back under the Feed Tube.

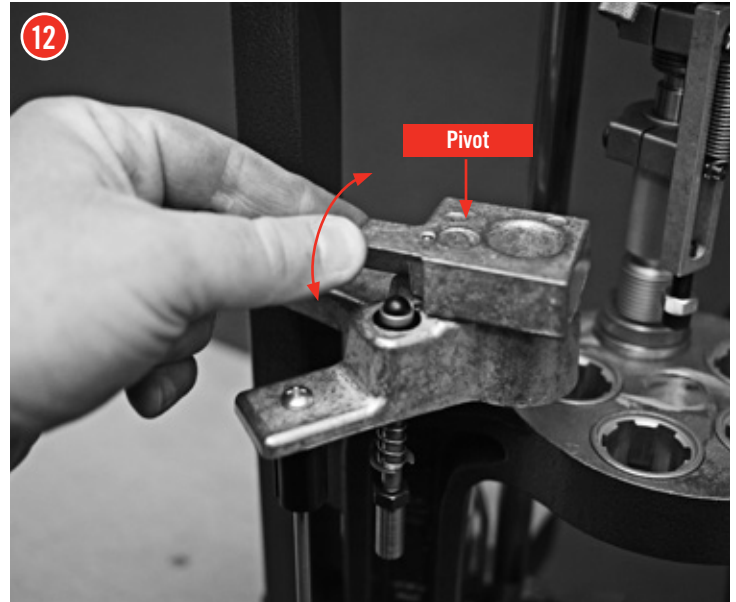

- 13** For small rifle cases, place the Pivot Adapter Bushing into the hole of the Pivot Adapter.

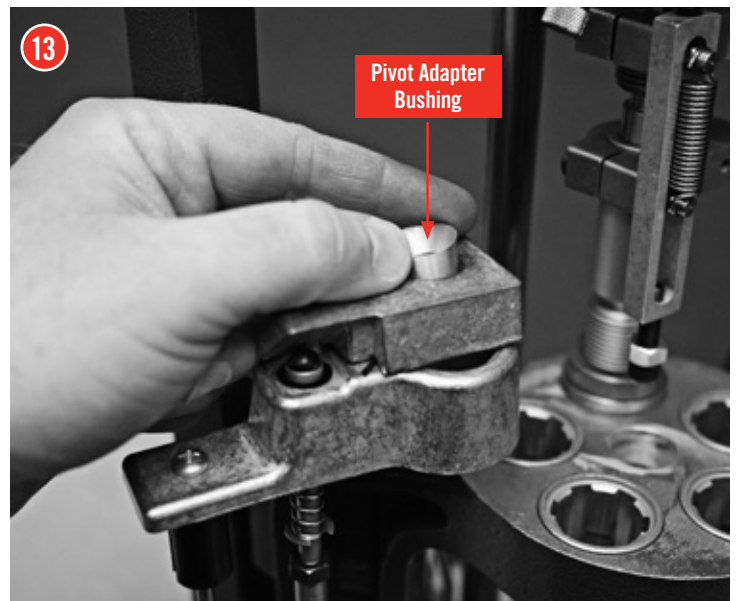

- 14** Place the Pivot Adapter on top of the pivot for rifle cases. Refer to page 45 for proper Pivot Adapter.

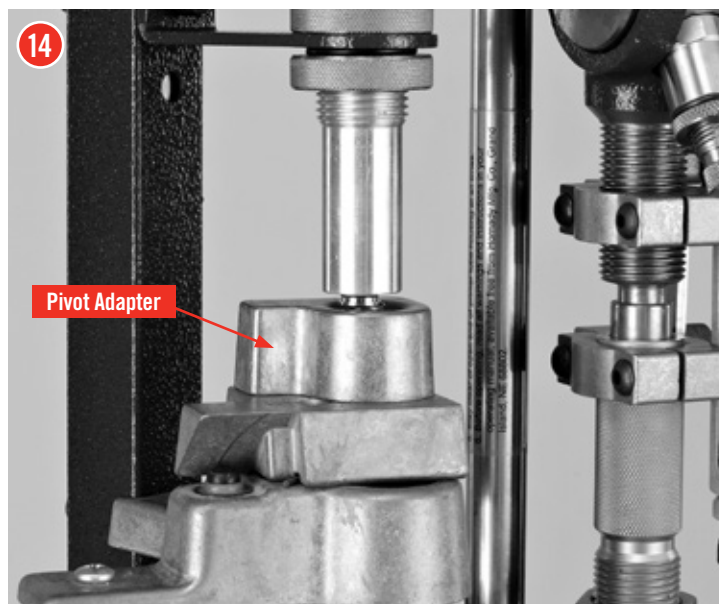

Placing the Feed Tube End on the Assembly.

- 15** Screw one Lock Ring (17) on the Feed Tube End Primary.

Place it through the hole on the Feed Tube Mounting Bracket (16). Determine whether a Feed Tube Insert is necessary. (Refer to Page 13). If so, place the insert inside of the Feed Tube End Primary. Adjust the height of the Feed Tube End to have approximately 1/16" below the bottom of the tube to the case mouth. With some cases such as the 357 Mag, it may be necessary to adjust the Feed Tube End to where the case mouth sits up inside of the Feed Tube End. These are both starting points, and for your particular case, it may need to be adjusted a little differently. (*Long skinny cases, which are shorter than 1.50" long, will not work with the Pivot Adapter.*) They may need to be supported at the mouth of the case by the Feed Tube Ends. This will allow the case to feed down the Drop Tubes without falling over and causing double or triple feeds.

Screw on the other Lock Ring (17).

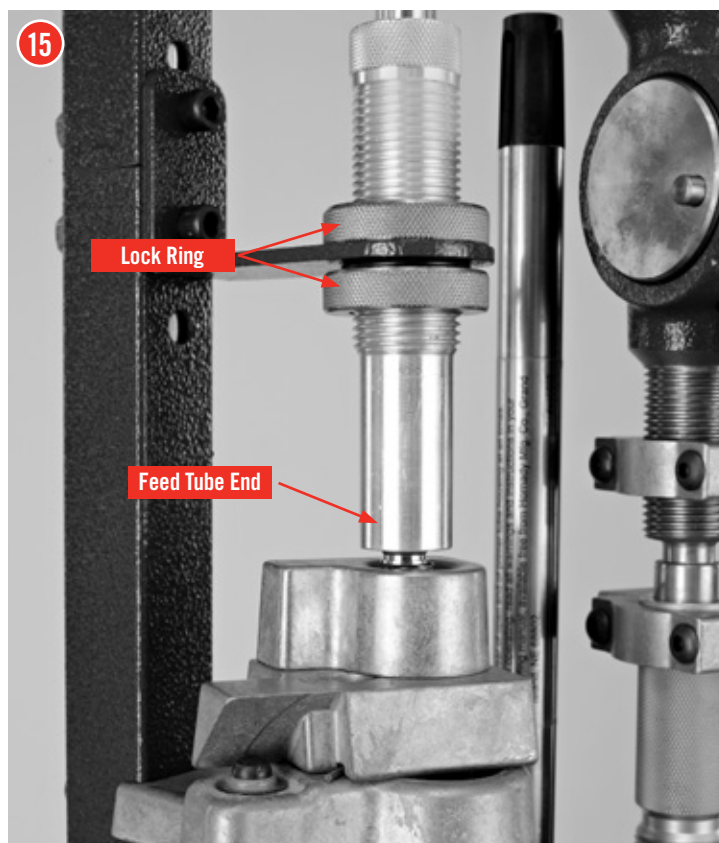

Placing the Feed Tube end on the Assembly (con't).

- 16** Select the proper Feed Tube and insert it in the top of the Feed Tube End. If you select the Small Feed Tube, you will have to use the Plastic Feed Tube Small Bushing (66). Refer to page 45.

(When feeding some cases, such as the 357 Mag, you may notice that the base of the case will not fall into the hole of the Pivot every time. The base will ride on the radius of the pivot hole. This is correct because when the Push Rod starts to rotate the Pivot, the case will fall into the hole.)

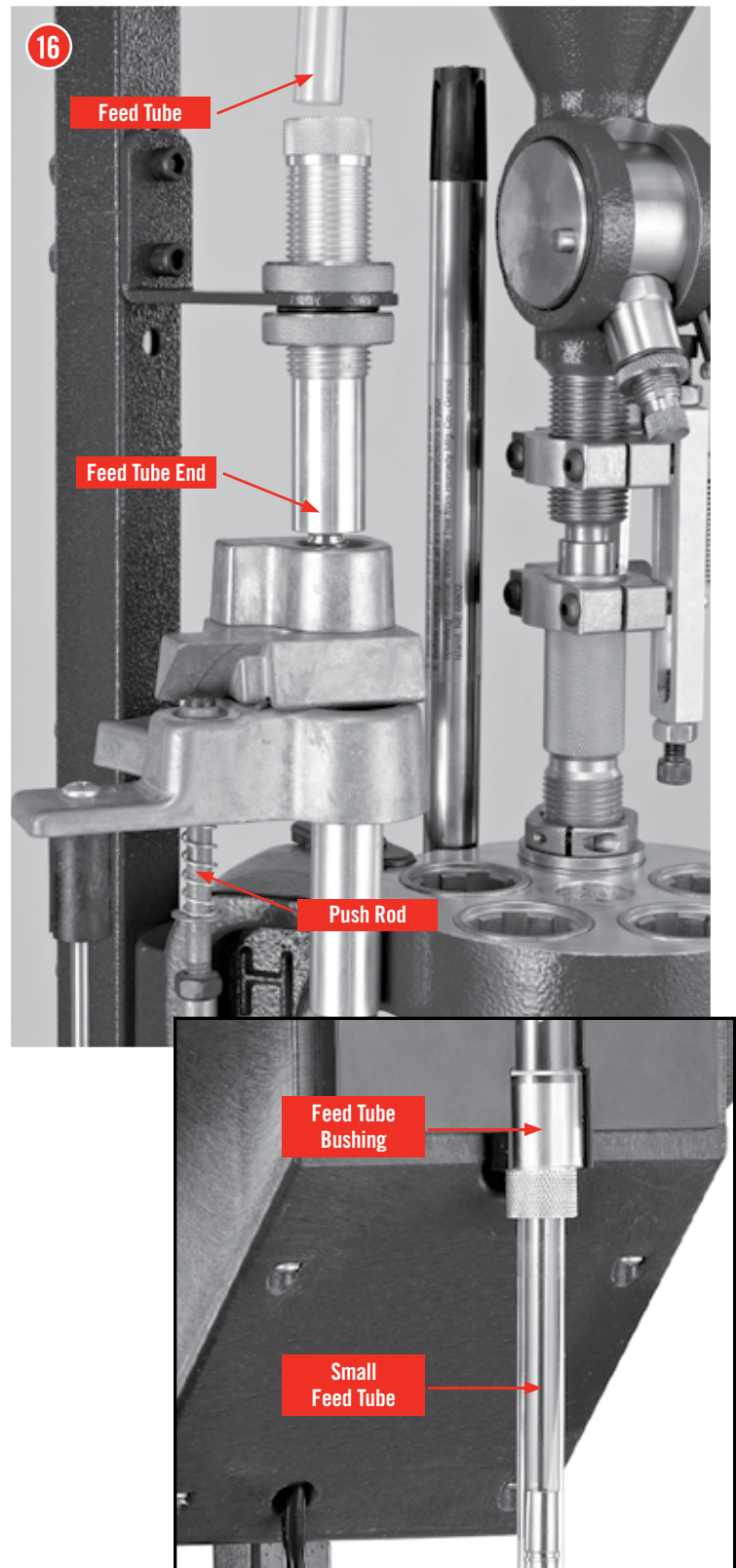

Placing the Feed Bowl Hopper on the Assembly

- 17** Select the Case Feed Plate for your application.
Refer to page 45.

To install the Case Feed Plate, place Feed Plate over the motor shaft and rotate until pawls on motor shaft engage the two slots on the bottom of the Feed Plate.

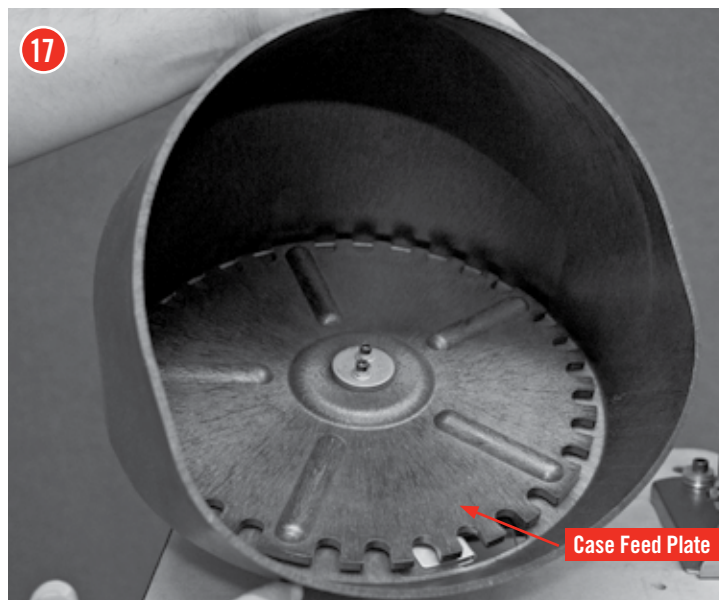

- 18** Slide Case Feed Hopper on to the Square Tubing and the Feed Tube.

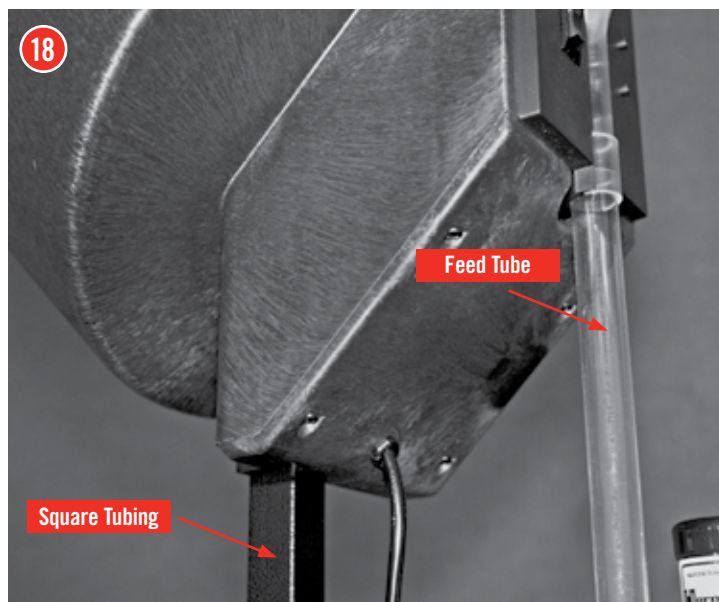

Maintenance of the Lock-N-Load® AP™ Case Feeder

As with all equipment, proper and routine maintenance will provide smooth operation and a longer life for your reloading press and Case Feeder. At the end of each reloading session, wipe off all spilled powder, any dirt, etc., from the press. Check all moving parts for dirt or spilled powder and remove with a clean rag.

Lock-N-Load® Auto Progressive (AP™) Pistol Bullet Feeder

PARTS LIST

Item No.	Production Part No.	Qty.	Description
1	392011	3	Nut Hex 10-32 Zinc
2	399209	1	Steel Knurled Thumb Screw
3	399213	1	Tube Spring Clamp
4	399210	1	BHCS 10-32 X 1/4
5	399214	1	Tube Bullet Drop Funnel Large
5	399215	1	Tube Bullet Drop Funnel Medium
5	399216	1	Tube Bullet Drop Funnel Small
6	399205	1	Screw Adjustment Bullet Feed
7	399206	1	Screw Lock Nut Adjustment
8	398067	1	Rubber Washer Flat
9	399208	1	Center Plate Adjustment Nut
10	398400	1	Thumb Screw 1/4-20 X 1/2
11	399202	1	Hopper Turning Plate
12	398401	2	Screw FHSCS 10-32 X 1/4
13	399201	1	Bullet Feed Wheel - Pistol
14	399212	3	Nut Hex 1/4-20
15	399207	1	Center Pin Bullet Plate
16	399218	1	Spur Gear 1.500 P.D., 30 Tooth
17	398313	8	Screw FHSCS 10-32 X 3/4
18	399203	1	Bullet Feeder Base Plate
19	398402	1	Ideler Gear Shaft

Item No.	Production Part No.	Qty.	Description
20	399102	1	Spur Gear 1.200 P.D. 24 Tooth
21	399244	1	FHCS 1/4-20 X 1/2
22	398381	1	Pin Spirol 1/8 X 3/4
23	398399	1	Motor Bullet Feeder
24	399222	2	Screw Bullet Wiper
25	399242	6	Nut Wing 1/4-20
26	399223	2	Spring Wiper Bullet Feed
27	399224	2	Thumb Screw 8-32 X 1/2
28	399217	1	Tube Holder Bullet Feeder
29	399200	1	Bullet Feed Hopper
30	399211	2	SHCS 1/4-20 X 2
31	390128	6	Washer Flat 1/4"
32	398418	1	Bushing (HEYCO 1147) Black
33	399219	1	Tube Drop Small
33	399243	1	Tube Drop Medium
33	399221	1	Tube Drop Large
34	398332	1	Switch 2 Position
36	399358	1	Support Tube-Bottom
37	399359	1	Support Tube-Top
38	399360	2	1" Square Finishing Plug
39	399362	2	1/4-20x2.5 Carriage Bolt

Lock-N-Load® AP™ Pistol Bullet Feeder

EXPLODED VIEW

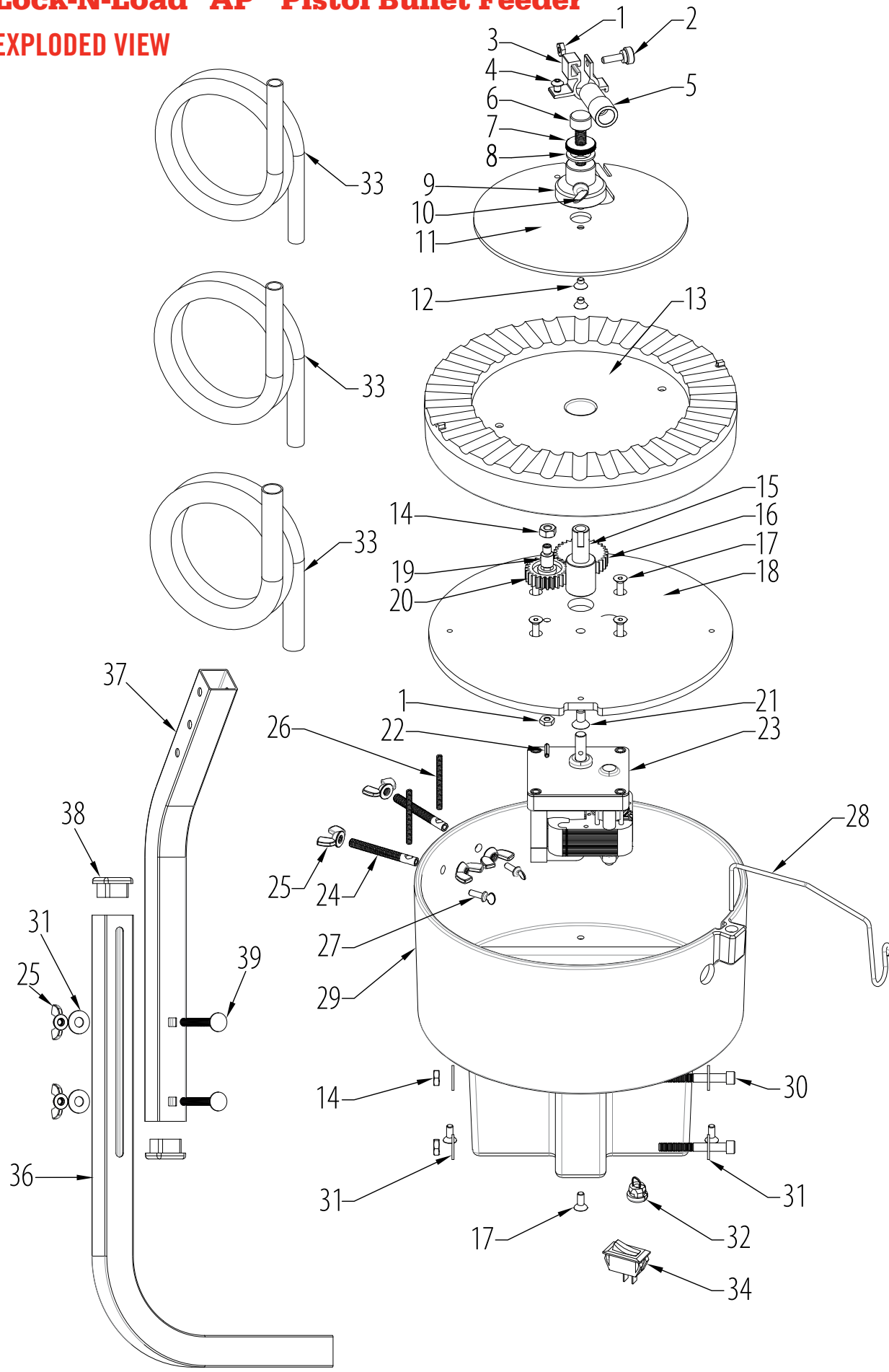

Lock-N-Load® AP™ Pistol Bullet Feeder

OVERVIEW

Your new Lock-N-Load® AP™ Pistol Bullet Feeder has been packaged to ensure minimal vibration and damage during transportation.

Remove all the parts from the packing box (see page 2) and spread them over a large flat surface. **Refer to the parts list and exploded view on the previous pages** and check to make sure all necessary parts are identified.

This manual provides step-by-step instructions that make set-up and operation easy and understandable.

Tools needed for assembly and set-up:

- 7/16" End Wrench
- 3/16" Hex Wrench
- 1/4" Drill Bit
- Electric Drill



Mounting the Bullet Feed Hopper to the Square Tubing Mounting Bracket

- 4 Slide the Hopper (29) over the top of the Square Tubing Mounting Bracket (37), with the open face of the Hopper facing the front of the bench or table.

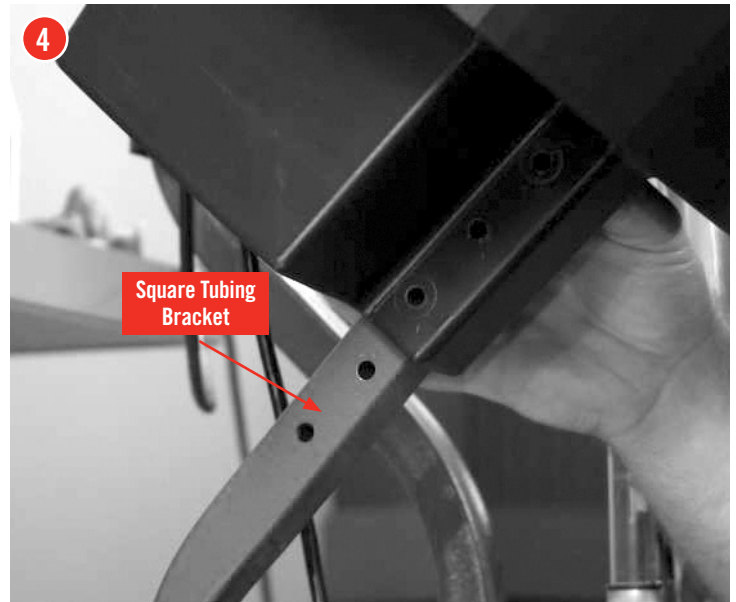

- 5 Place a ¼-20 X 2 SHCS Bolt (30) with one ¼" Flat Washer (31) through the top hole of the Bullet Feed Hopper and the Square Tubing Mounting Bracket.

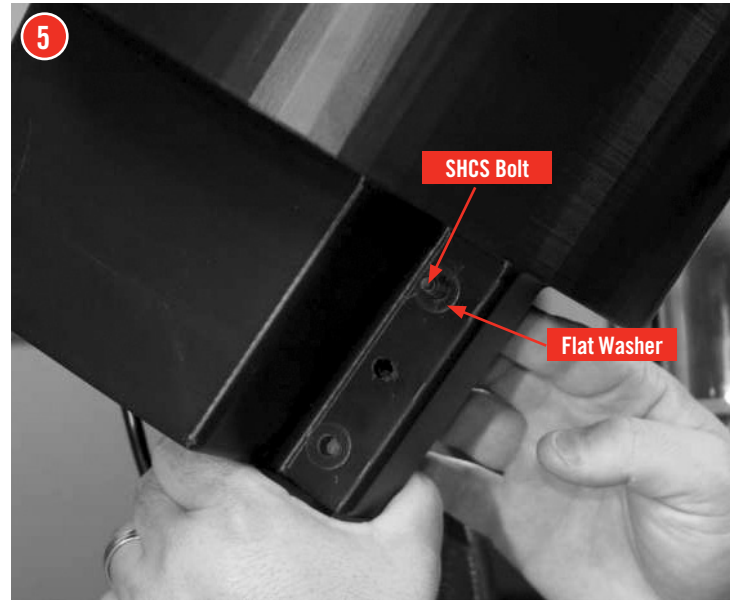

- 6 Place a ¼-20 X 2 SHCS Bolt (30) with one ¼" Flat Washer (31) through the bottom hole of the Bullet Feed Hopper and the Square Tubing Mounting Bracket.

If you are having issues with bullets not being able to keep up feeding (approximately 100 bullets in 5 to 6 minutes), switch the bolt from the bottom hole to the middle hole.

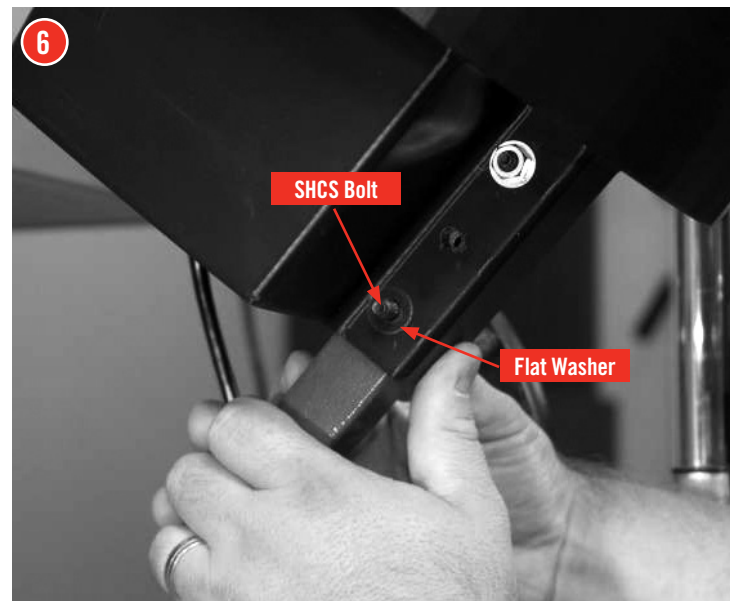

- 7 Place a ¼" Flat Washer (31) over the end of each of the two Bolts just previously placed through the Bullet Feed Hopper and Square Tubing Mounting Bracket.

Place a ¼-20 Hex Nut (14) onto the two ¼-20 X 2 SHCS Bolts and tighten snug.



Bullet Feed Hopper Set Up

- 8 Loosen ¼-20 Thumb Screw (10).

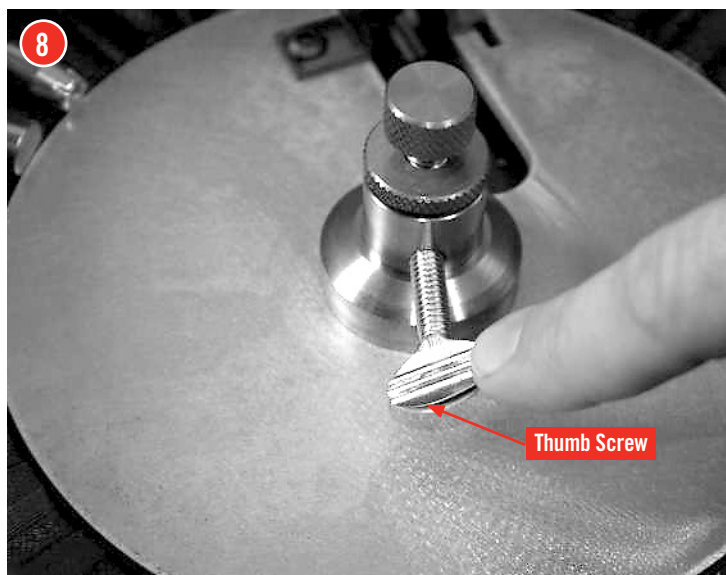

- 9 Loosen Lock Nut (7) on the Adjustment Screw (6).

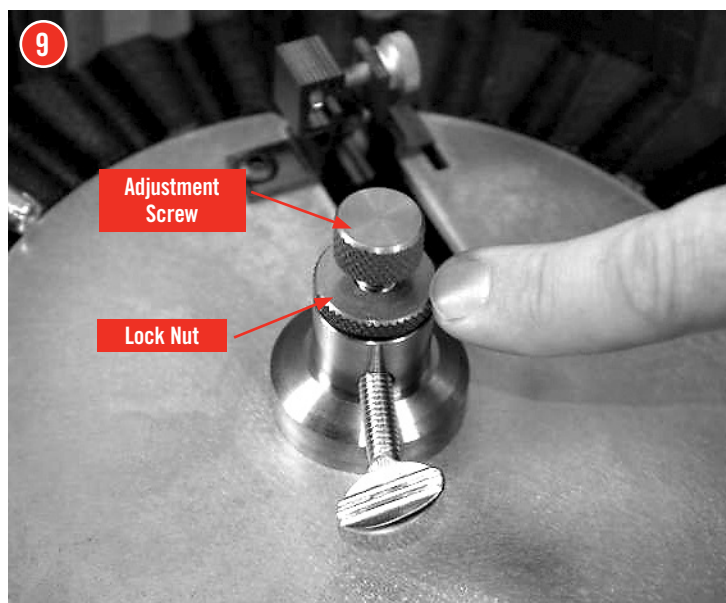

Bullet Feed Hopper Set Up (con't)

- 10** Raise the Hopper Turning Plate (11) by turning the Adjustment Screw (6) clockwise.

Raise the Bullet Guide Plate above the bottom of the slots on the Bullet Feed Wheel Pistol far enough to hold a bullet base first against the Bullet Feed Wheel Pistol.

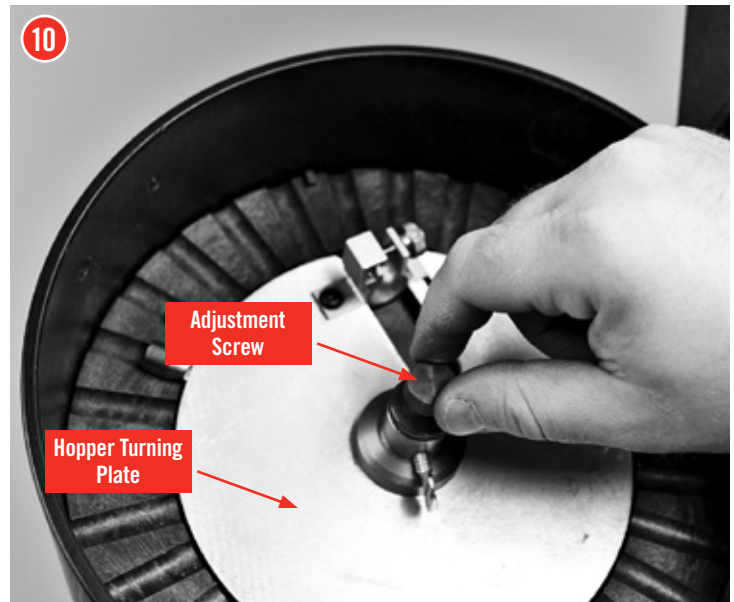

- 11** Place a bullet that you plan on loading facing base first up against the Bullet Guide Plate and against the Bullet Feed Wheel Pistol. Next to this bullet, place another bullet so that the nose is facing the center of the Bullet Feed Wheel Pistol.

You will then need to adjust the Bullet Guide Plate either up or down to get a bullet to stay on the Bullet Feed Wheel Pistol base first, but fall off the Bullet Feed Wheel Pistol if the bullet is nose first towards center of the Bullet Feed Wheel Pistol.

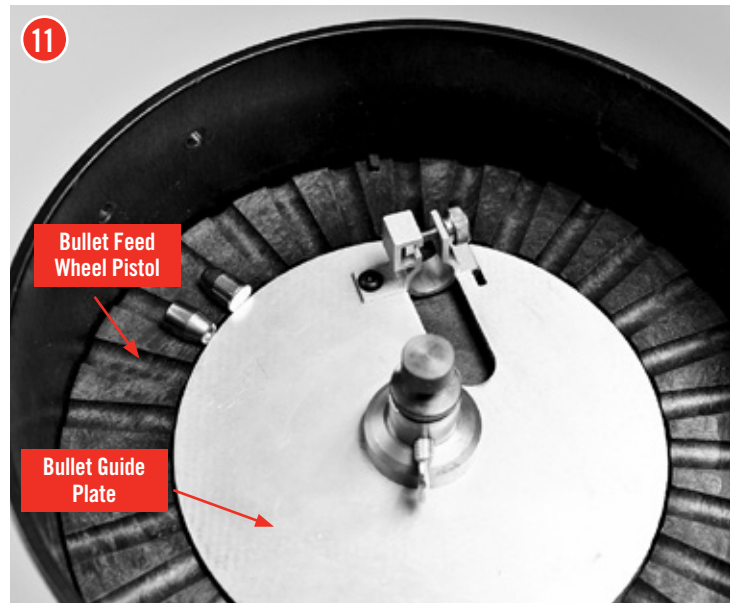

Bullet Wiper (Bottom Wiper)

- 12** Install the wipers as with one Wing Nut (25) installed on the outside of the Bullet Feed Hopper on the Wiper Screw (24).

Loosen the wing nuts.

Place two bullets nose to nose in a slot close to the height of the first or bottom wiper screw and Wiper Spring (26).

Adjust the first wiper spring and screw to wipe off the outside bullet.

Tighten down the two wing nuts and the thumb screw.

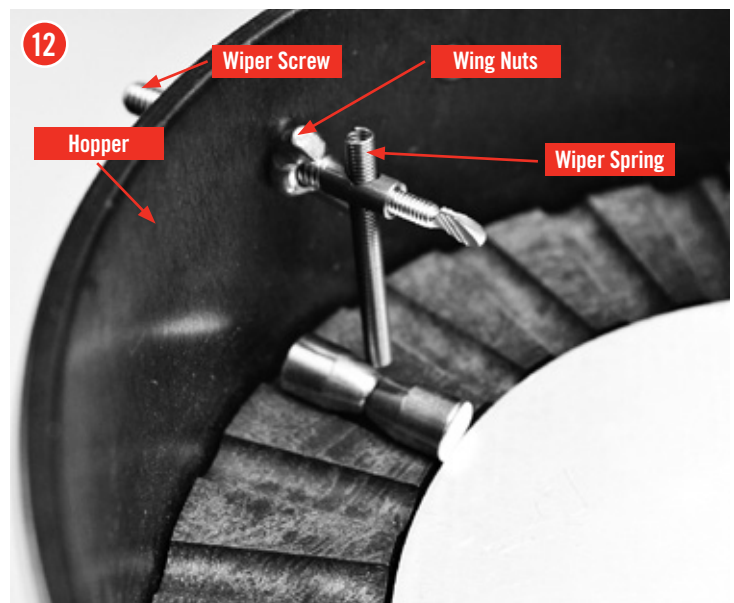

Bullet Wiper (Top Wiper)

- 13** Install the wipers as shown in with one Wing Nut installed on the outside of the Bullet Feed Hopper) on the Wiper Screw.

Place one bullet facing the center of the Bullet Feed Wheel Pistol base first. Next to it, place a bullet facing nose first to the center of Bullet Feed Wheel Pistol. The bullet that is facing nose first, push the nose down a little so the base is sticking up.

Adjust the second Wiper Spring and Wiper Screw to just miss the nose of the first bullet but kick the base of the second bullet.

Tighten down the two Wing Nuts and the Thumb Screw.

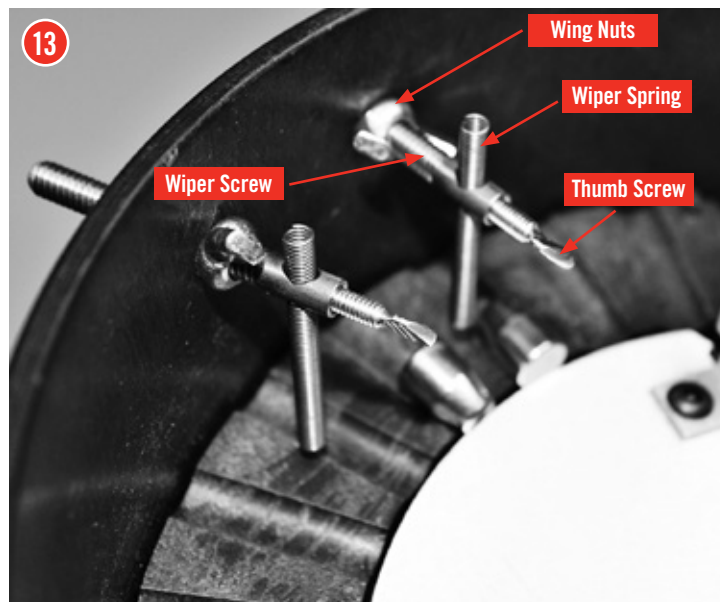

Drop Funnel

- 14** Select the correct size of Drop Funnel for your application.

9MM/38/.357	(375 I.D.)	Item No. 399216
40 S&W/10 MM	(406 I.D.)	Item No. 399215
.44/.451/.452	(530 I.D.)	Item No. 399214



- 15** Insert the Drop Funnel (5) into Tube Spring Clamp (3). You will want the front edge (outside edge) of the Drop Funnel as close to the Bullet Feed Wheel Pistol without touching the Bullet Feed Wheel Pistol.

Tighten the Knurled Thumb Screw (2) on the side of the Tube Spring Clamp. Only snug this screw, **DO NOT** over tighten this screw.

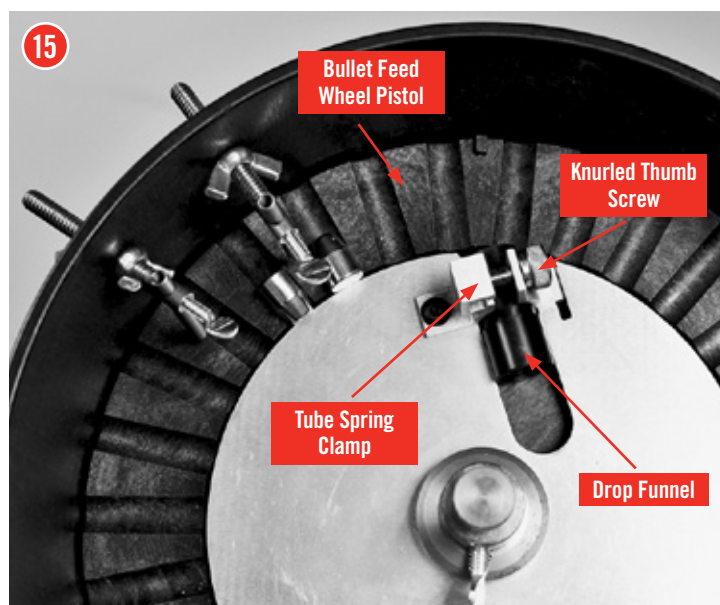

This completes the basic assembly of the Ammo Plant.

Continue to the Changeover/Setup Section for detailed instructions on how to setup the Ammo Plant for a specific cartridge.

Operation of your Lock-N-Load® Auto Progressive Press

The Hornady Lock-N-Load® AP™ utilizes a high strength aluminum alloy frame with a compound linkage system which operates the 2" diameter cylindrical ram. The Ram houses a drive shaft that is attached to the shell plate at the upper end and the index wheel at the lower end. The toggle contains two spring actuated pawls which alternately engage the index wheel to advance the shell plate through the different reloading stations.

As the handle is lowered, the right Pawl contacts the Index Wheel, advancing the Shell Plate during the first 1 1/2" of upward travel of the Ram. With this upward travel, the cases become aligned with the dies at the top of the Press. As the Shell Plate comes to the top of the press, it guides the cartridge cases into the five die stations to perform the reloading operations except priming.

The handle is then raised to complete the stroke, lowering the Shell Plate. When the Shell Plate comes to within 1 3/4" of the bottom, the left Pawl engages the Index Wheel which advances the Shell Plate into position over the primer to seat it into the case that was just sized and de-primed. Pushing back on the handle with moderate force will seat the new primer into the case.

Once the dies are in place, and all stations are filled, the proper sequence for reloading is listed below.

- Place an empty case into station one. (Using the optional Lock-N-Load® AP™ Case Feeder, this step is automatically done for you.)
- Insert bullet into the powder charged case in station four (or use the optional Lock-N-Load® Bullet Feeder)
- Lower the handle.
- Powder drops into the newly primed case at station three.
- Raise the handle and seat a new primer in the de-primed case that has now moved to station two.
- Loaded cartridge is automatically ejected at station five when handle is raised.

Installing the Shell Plate

- Put a small amount of general-purpose grease on the Shell Plate Ball Detents located on bottom side of Shell Plate (3), and on the top surface of the Sub-Plate (6).
- Align the Shell Plate (3) with the keyed Drive Hub (5).
- Place the 3/8" Shell Plate Retainer Bolt (1) through the 3/8" Flat Washer (2), (large end up) and thread the bolt into the Drive Hub (5).
- Tighten the bolt (1) using a 5/16" Allen wrench, only tight enough to prevent it from coming loose.
- Stretch the Case Retainer Spring over the top of the Shell Plate (3).
- While cycling the Press, push the Case Retainer Spring into the relieved area on the Sub-Plate (6). You will have to cycle the press a couple of stations to receive these results.

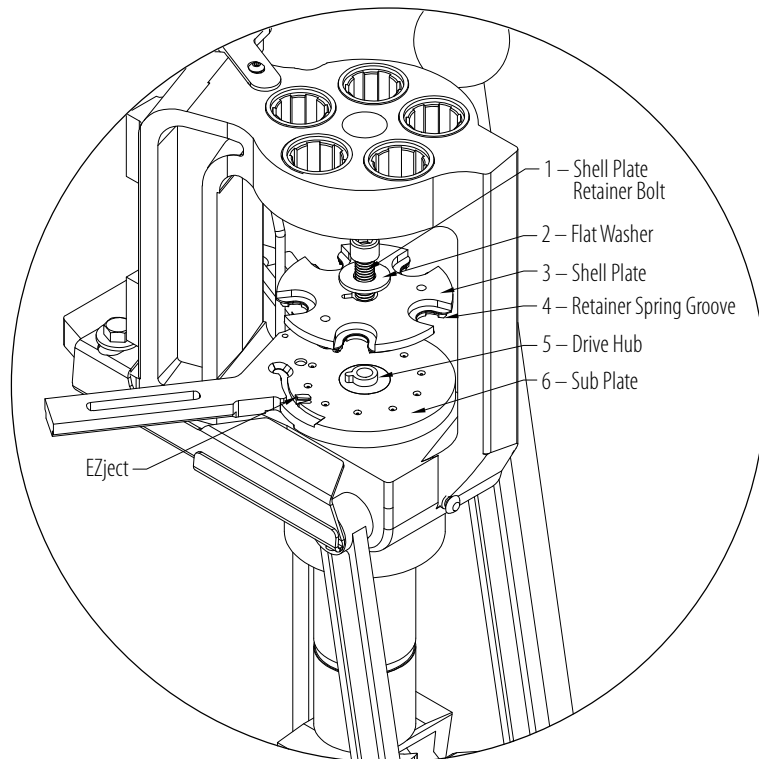

Loading the Primer Tube

Carefully transfer the primers out of their factory package into a Hornady Primer Turning Plate and orientate them “shiny side up.” Then holding the Primer Filler Tube (large of small) like a pencil bring the plastic primer pick up tip over each primer and gently press it over the primers. The primers will be pushed into the filler tube one on top of another. Continue loading the primer filler tube until you have picked up approximately 100 primers.

Make sure the cotter pin is in place; turn the Primer Filler Tube upside down. At the top of the exposed Primer Filler Tube, there may be several primers still held and visible. Gently shake the tube to release the primers.

Align the Primer Filler Tube (large of small) to the Primer Feed Tube (large of small) using the Primer Tube Support. Remove the cotter pin from the Primer Filler Tube (large of small) and fill the Primer Feed Tube (large of small). The capacity of the primer tube is 100 primers.

Do not over fill the primer tube.

Insert the Primer Follower into the Primer Tube (large of small). This will help the primers feed more reliably.

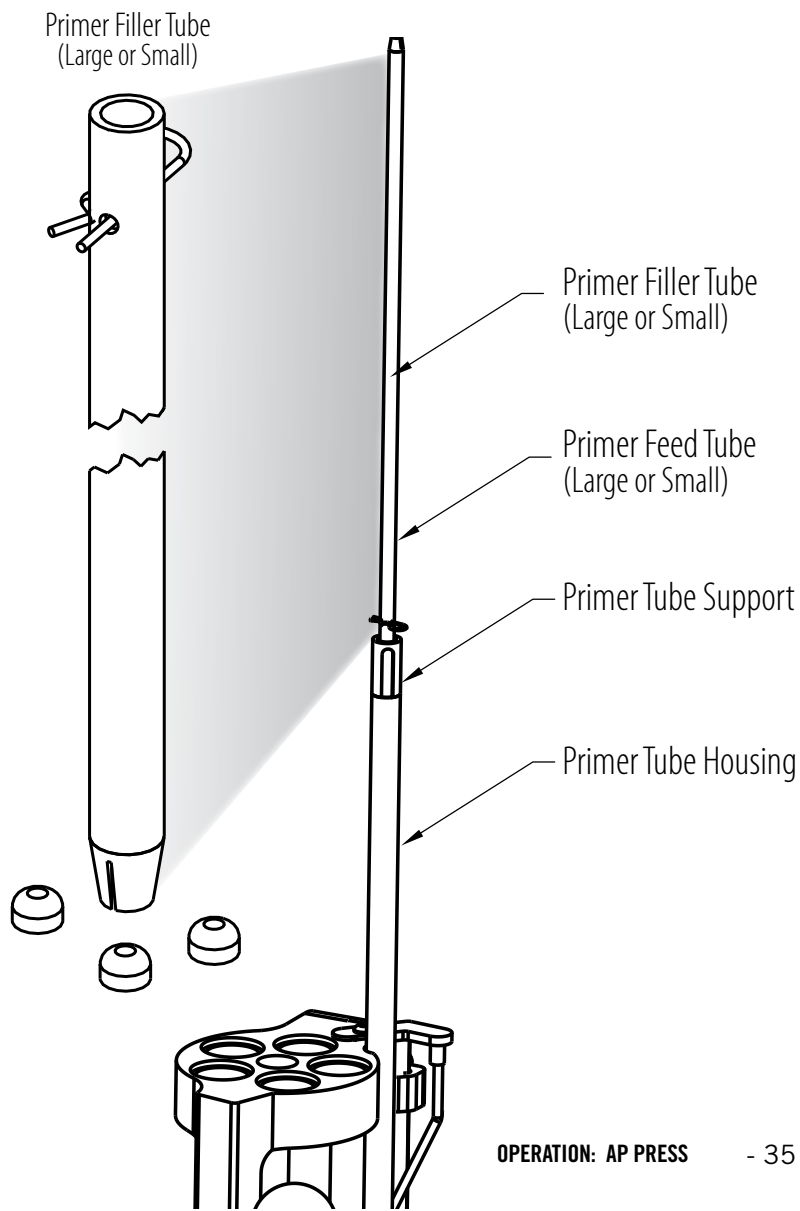

Preparing to Load

To begin reloading, start with a single empty cartridge case and run it through all of the loading stations. This will allow you to check your adjustments. *Refer to instructions provided with the die set for set up and proper adjustment.*

Sizing a case

- Make sure the sizing die is adjusted properly, and the de-priming pin knocks out the old primer.

Seating a primer

- Check and make sure the Primer Slide picked up a primer from the Primer Tube (large or small).
- When you cycle the press and the handle comes to a stop, you will have to push the handle away from you past the stop to seat the primer. Push until it stops but don't force it. Seating the primer requires a firm push.
- Lower the handle of the press slowly to rotate the shell plate to start the next operation. If there is resistance on the shell plate, the primer is improperly seated and not allowing the Shell Plate to rotate.

Drop powder in the case using the case activated powder drop

- Verify the weight on a properly calibrated scale.

Seat a bullet in the powder charged case

- Begin lowering the handle to rotate the shell plate to this station.
- Place a bullet on top of the case and lower the handle the rest of the way. (You may need to position the bullet over the case neck between your thumb and forefinger until the bullet enters the alignment sleeve).

Station 5

- This station can be used for a Taper Crimp Die when reloading pistol cartridges that headspace off the case mouth.
- * *Any manufacturer's Taper Crimp Die will work in Station 5 with the AP's EZject™ System.*
- Properly adjusted, a taper crimp die removes all case-flare from the expander die without damaging or squeezing into the bullet.

Next, lower the handle, advance the shell plate to the next station. The loaded round will rotate and contact the EZject™ System underneath the shell plate. This EZject™ System will automatically eject the loaded round from the press. Never force the handle. Measure the case for proper length and check it against the data in your reloading book.

Once you are satisfied with the first completed cartridge, repeat the process with another single case, advancing slowly from station to station until you eject the finished cartridge from the press with the case ejector.

After you are comfortable, load the press with consecutive cases for reloading. **Do not rush!** After you advance the cases through each station, inspect everything to insure proper function at each station. If anything looks out of place, or if you lose track of what you are doing, **STOP!** Remember, it's safer to begin slowly than it is to assume you need to reload a large number of cartridges during each session. Don't force the handle at any time, and be sure that all mechanical parts are properly lubed.

SAFETY NOTE: Be safe! Double check your powder loads at frequent intervals to insure the powder charge is working properly.

Adjusting the Auto Advance Mechanism

The Auto Advance Mechanism is fully adjusted at the Hornady factory and should not require further adjustment. In the event that you feel your shell plate is not advancing properly, check all other options listed in this manual before attempting to adjust the mechanism's pawls.

All adjustments should be made in extremely small increments.

Through everyday use, the pawls on your press may gradually wear and may need to be adjusted to compensate for this wear. Before making adjustments, you should understand what each pawl does.

As the operating handle is lowered and raised through a complete cycle, each pawl in turn engages the index wheel at the bottom of the press. The index wheel is connected through the driveshaft to the shell plate. As each pawl engages the index wheel it advances the shell plate either at the top or bottom of the cycle.

The right pawl (as you face the press) advances the shell plate as the ram travels up when the handle is pulled down. The left pawl advances the wheel on the down stroke of the handle and should advance the shell plate to the detent holes in the sub-plate. If the shell plate doesn't advance enough on the down stroke of the ram, only the left pawl needs adjustment.

The right pawl is too low if the shell plate stops short of the detent, which can be felt as you rotate the shell plate into place by hand in a clockwise direction (CW). If the pawl is too high, you will feel a slight double click on the handle as the pawl disengages and the shell plate is locked into place by the detents.

The same is true for the left pawl which indexes on the up stroke of the handle (down stroke of the ram.) Likewise, if the plate doesn't advance far enough on the up stroke of the ram, only the right pawl needs to be adjusted. Don't assume that both pawls need adjusting.

Do only one pawl at a time to keep from becoming confused.

The height of each pawl determines how far the shell plate will advance when that pawl comes in contact with the indexing wheel. To adjust the pawls, increase the height of the chosen pawl to increase the advancement of the shell plate in that direction. Or decrease the height of the pawl to decrease the shell plate advancement in that direction.

There is a set screw on each pawl.

- Turn the set screw clockwise (CW) to lower the pawl.
- Turn the set screw counter clockwise (CCW) to raise the pawl.

Become familiar with these pawls from the onset and see how they operate. You will then find it much easier to adjust the pawls, should you need to do so in the future.

For additional assistance, please contact our technical service staff at 800-338-3220 or send email to hornady.com/contact_us.

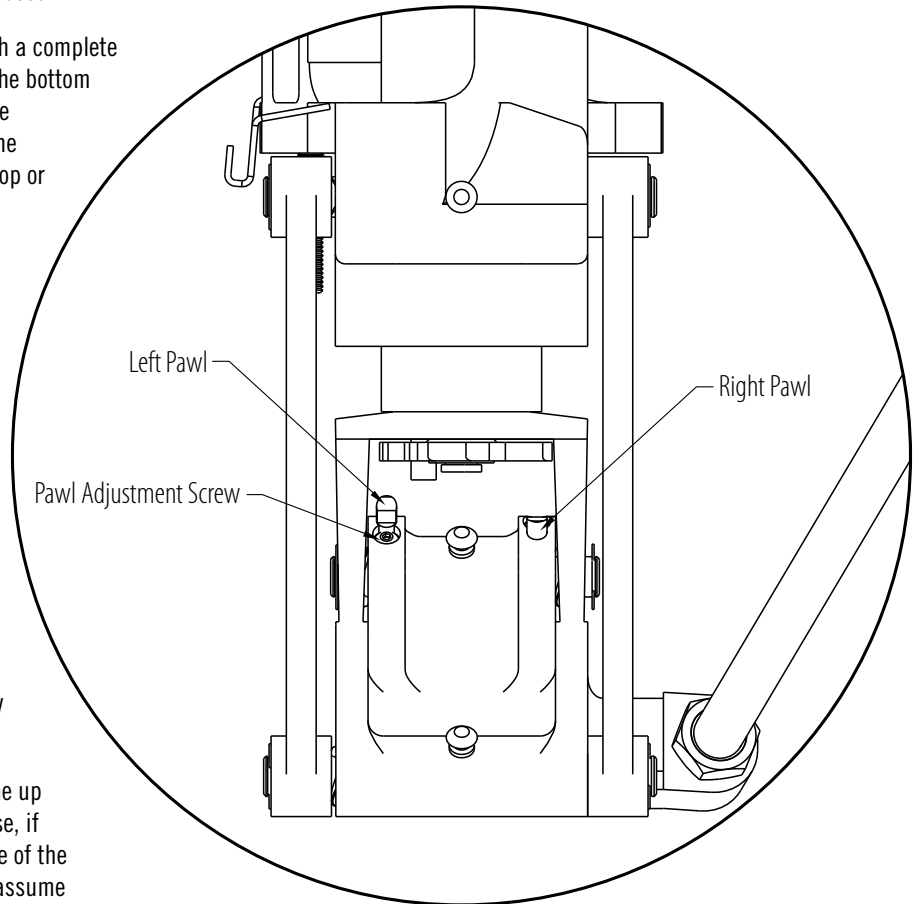

Setup / Changeover of Auto Progressive Reloading Press

When changing calibers on the Lock-N-Load® AP™ Press, three components may need to be changed or verified.

- Shell plate
- Dies
- Primer Components
 - Primer Slide
 - Primer Tube
 - Primer Punch



Shell Plate

Determine which shell plate is required for your application

Refer to Appendix A for proper Shell Plate selection.

NOTE: Hornady shell plates that are sold in the plastic boxes are the only ones that will fit the AP Press with EZject™ System. These shell plates (which are sold separately) are manufactured with a groove on the bottom side.

Refer to **ASSEMBLY: AP PRESS Page 8** for instructions on removing and installing the Shell Plate

Determine the dies needed.

The Hornady Lock-N-Load® AP™ Press is designed to use Hornady dies as well as most other dies with a 7/8"-14 threaded body. However, the characteristics of each die is different and will determine the setup and capabilities of the press. For example, using the Hornady Pistol Taper Crimp/Seating Die will free up a station on the press so that a Powder Cop Die may be used. Please see the various layout options below to help locate your dies on the press.

Die Mounting Instructions

For initial die cleaning and individual die adjustment instructions, please refer to the instruction sheet that came with your die set.

Lock-N-Load® quick change bushing system

The Lock-N-Load® system is based on the positive locking action of the bolt action rifle. Just like the bolt action rifle, the locking action is incredibly strong and simple.

Once the dies and the powder measure are adjusted for loading, these settings are locked in place by tightening the Lock Ring that is provided with all Hornady dies and powder measures.

How the Lock-N-Load® works:

- Insert the Lock-N-Load® Bushing into the Press and turn it clockwise to lock it in place.
- Adjust the die to the desired position and lock the setting in place with the die's lock ring.

Once Lock-N-Load® Bushings are installed, Dies and Powder Drop can be removed from the press with a quick counterclockwise turn. Since the Lock-N-Load® Bushing is locked in place, the dies and the Powder Drop remain set exactly as you left them.

For added speed and convenience, Hornady® offers inexpensive Quick Change Powder Dies for use with the Case Activated Powder Drop.

CHANGE-OVER

Die Setup Configurations

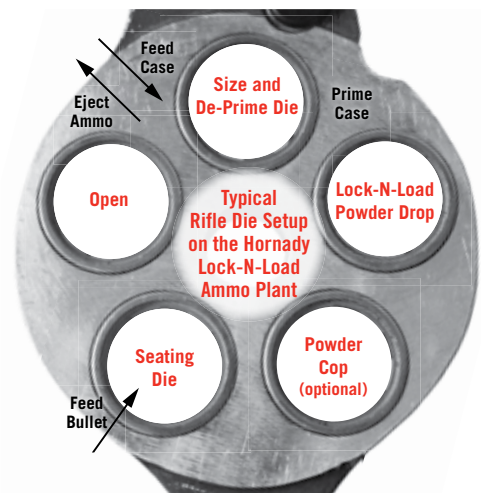
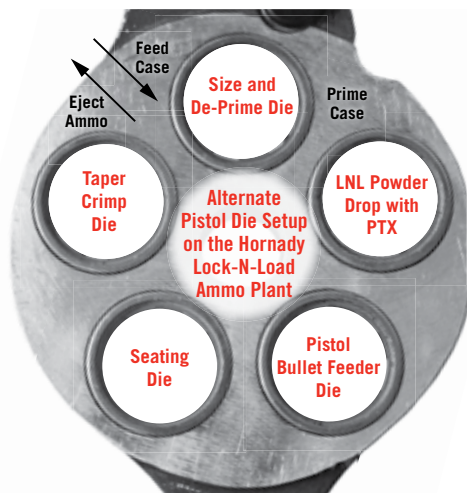
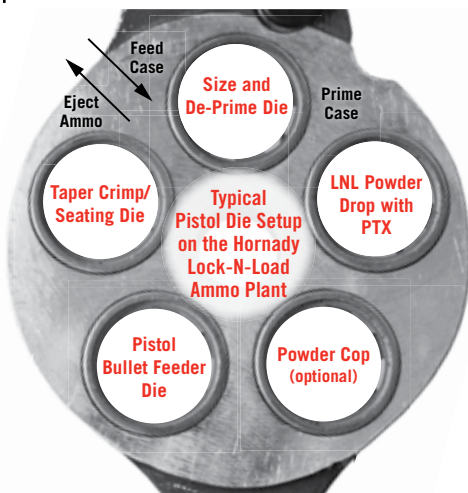

Changing Primer Components

1 When changing from a large primer to a small primer (or vice versa), you need to change the Primer Feed Tube Primer Slide and Punch Assembly.

2 If there are primers in the Primer Feed Tube, you will need to empty it before changing the tubes. If the Primer Feed Tube is already empty, skip to next step.

Remove the Cap Screw, cup your hand under the Primer Tube and rotate the Primer Feed Body Assembly clockwise to catch the primers. After the tube is empty, rotate the body back in place and re-install the mounting screw.

3 Disconnect the Spring from the roller pin and remove the Primer Slide. Remove the Primer Tube Support and the Primer Feed Tube.

Fill the primer tube as described in the Operations Section.

4 The Primer Seater Punches are installed from the bottom side of the Sub-Plate. Raise the Ram to the top of the stroke. Use a wrench to loosen the Primer Seater Punch and unscrew it from the Sub-Plate. When installing a new Primer Seater Punch, tighten it snug with a wrench. Do not over tighten the Primer Punch.

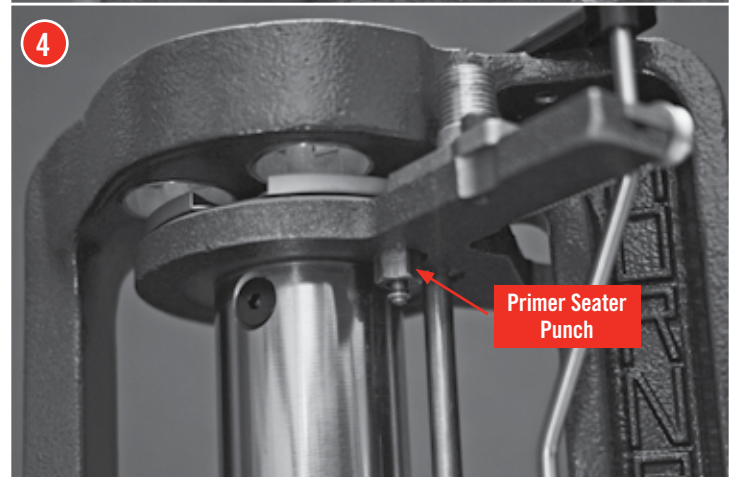
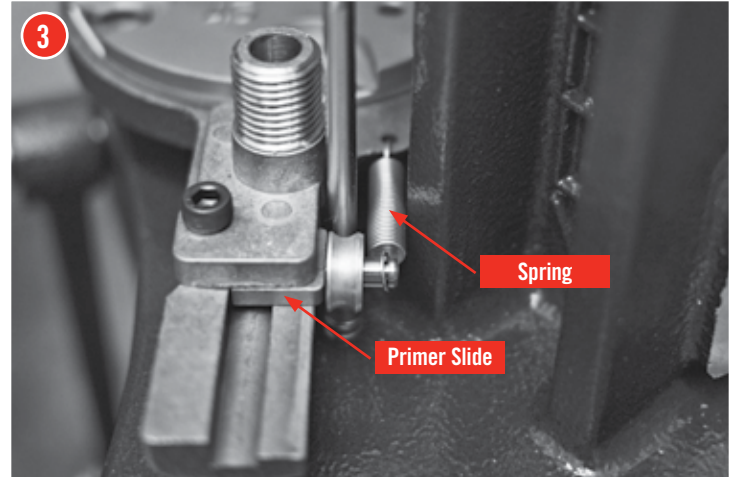
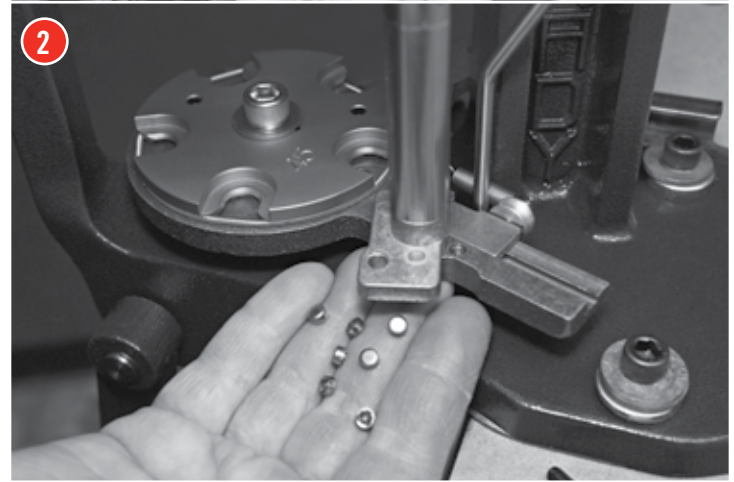
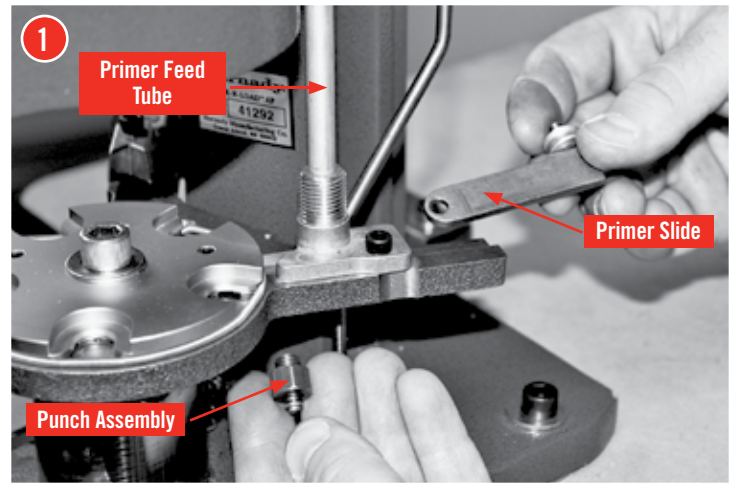

Setup / Changeover of Powder Measure

When changing cartridges, three components on the Powder Measure may need to be changed or verified.

- Powder type in the hopper.
- Metering Insert and/or Metering Rotor
- Powder Sleeve or PTX Expander

Emptying Powder in Hopper

NOTE: The Lock-N-Load® Powder Measure should be emptied of all powder prior to storage. Prolonged exposure to powder may cause the plastic tube to become cloudy, discolored, or even brittle.

To remove powder from the Lock-N-Load® Powder Measure hopper, either use the Hornady® Powder Measure Drain Insert (sold separately 050125) or remove the entire Powder Measure assembly from the press, remove the cap, and pour back into the original powder measure container. Cycle the rotor a few times while holding the powder measure over a container to remove the powder from the rotor. Finally remove the Metering Insert to inspect for any residual powder.

Changing Meter Insert and Rotor

The Lock-N-Load® Powder Measure ships with two sets of Rotors and Standard Inserts. The Pistol Rotor and Standard Insert are for powder charges from approximately 0.5 grains to 17 grains. The Rifle Rotor and Standard Insert are for powder charges from approximately 15 grains to 100 grains.

Additional inserts are available and sold separately to make change overs and reloading quicker and easier by storing the Metering Insert with the die set so minimal adjustments are needed when changing cartridges.

- 1 To change the insert, press the button on the side of the rotor. While pressing the button, pull and wiggle the Metering Insert out of the Rotor body. To install the new Metering Insert, press and hold the button on the side of the rotor, align the flats on the Metering Insert with the body of the Powder Measure, and press the insert into the Rotor. Verify the insert is fully inserted by firmly pulling on the Metering Insert.

NOTE: If there is powder in the hopper and the Metering Insert is on the bottom of the stroke, removing the Metering Insert will cause powder to empty out of the Powder Measure hopper and onto your work area.

If you are changing from a pistol cartridge to a rifle cartridge (or vice versa), you will need to change the Rotor in the Powder Measure.

- 2 To remove the Rotor, first remove the Metering Insert following the Instructions above. Next, remove the two screws from the side of the Rotor. Slide the Rotor out of the Powder Measure body.
- 3 Insert the correct Rotor by gently sliding it into the Powder Measure body. The manufacturing tolerances are very tight on the both the rotor and Powder Measure body, so caution should be used to prevent causing damage to the either component. Insert the correct Metering Insert and reattach the linkage with the two screws.

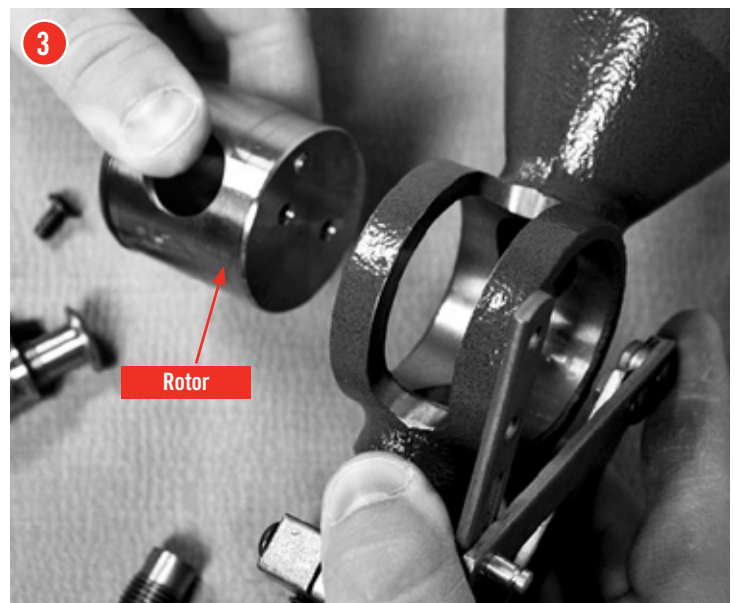

Changing Powder Sleeve or PTX Expander

As a general rule, rifle cartridge cases will use either the #1 or #2 Powder Sleeve. Pistol cases will need to use the PTX sleeves when the Hornady® Lock-N-Load® Bullet Feeder is being used. Otherwise the Universal Pistol Powder Sleeve will be used.

Refer to the chart below to select the proper Sleeve or Expander.

Remove spring, PTX Stop and loosen thumb screw.

Remove Powder Measure body from lower assembly.

Turn lower assembly over so powder sleeve drops out.

Replace with proper Powder Sleeve or PTX Expander.

Reverse steps above to reassemble.

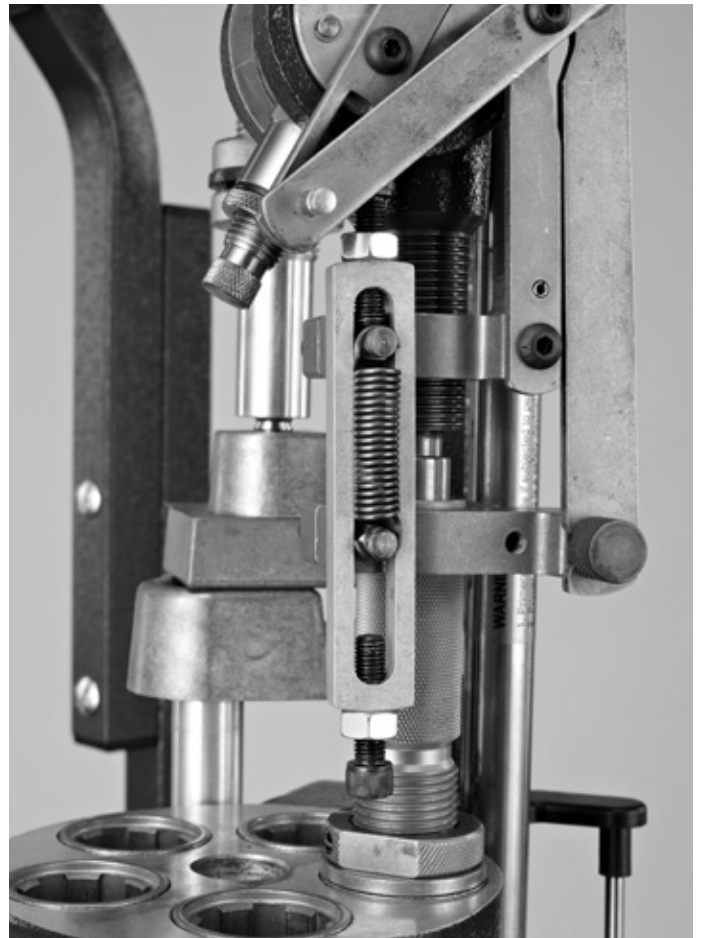

392700	392701	392702	392703
Universal Pistol Powder Sleeve	#1 Powder Sleeve	#2 Powder Sleeve	17 Cal. Powder Sleeve
Most Pistol Cases*	7mm to 45 Cal. Rifle Cases	20 to 270 Cal. Rifle Cases	17 Cal. Rifle Cases

*Does not flare case

290030	290031	290032	290033	290034	290035	290037	290038
.355 PTX	.357 PTX	.400 PTX	.430 PTX	.451 PTX	.452 PTX	.475 PTX	500 PTX
9mm Pistol Cases	38 Cal. Pistol Cases	10mm Pistol Cases	44 Cal. Pistol Cases	45 Cal. Pistol Cases	45 Cal. Pistol Cases	475 Cal. Pistol Cases	50 Cal. Pistol Cases

(PTX = Powder Thru Expander)

CHANGE-OVER

Adjusting the PTX Stop

Place Powder Measure Assembly onto the Lock-N-Load® AP™ Press in the proper station.

Remove PTX Spring and Stop from Powder Measure.

Insert a case into the shell plate under the powder measure and operate the handle to raise the ram to its highest position.

Lower the Powder Measure by rotating it clockwise into the press until the Powder Measure Rotor is fully rotated, but not contacting the end of the slot in the Powder Measure Body.

Lower the Ram and attach the PTX Stop and Return Spring between the two Spring Pins .

Check the Lock-N-Load® Powder Measure for correct positioning to avoid interference from other dies. Secure the Lock-N-Load® Powder measure to the Lock-N-Load® Bushing by tightening the lock ring.

NOTE: Clean the Case Activated Powder Drop at the end of each reloading session with a clean dry cloth to prevent a buildup of excess powder. This helps prevent the internal sleeve from sticking and spilling powder around the cartridge cases as they are loaded.

Install the PTX Powder Measure Stop

The PTX Powder Measure Stop (item no. 290049) is designed to be used in conjunction with our PTX Expanders and the Case Activated Powder Drop. The PTX Powder Measure Stop serves as a way to precisely and positively stop the upward travel of the Lock-N-Load® Powder Measure which allows the PTX Expanders to deliver consistently flared case mouths.

- 4 Make sure that the powder measure, using the Hornady Case Activated Powder Drop, is set properly as per the instructions included with that unit – the powder measure should be cycling completely through its range of motion. Remove the vertical spring from Case Activated Powder Drop.

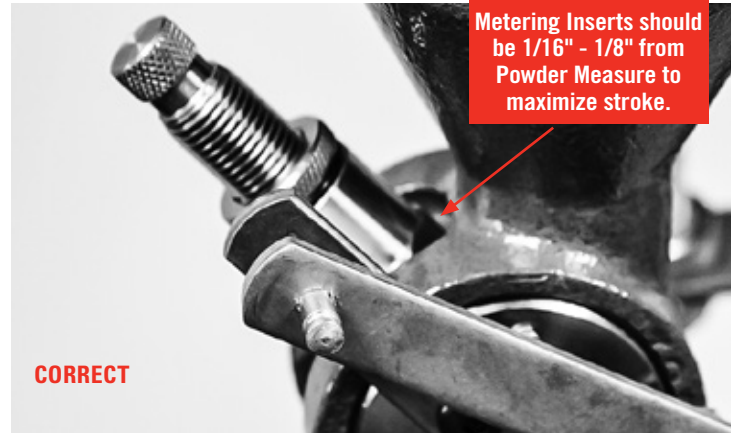
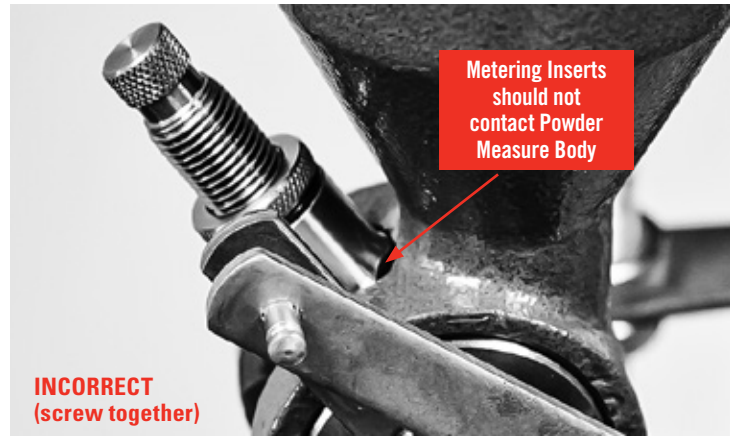

5 Holding the PTX Powder Measure Stop, unscrew one of the cap screws until the threaded end of the screw is flush with the inside of the slot.

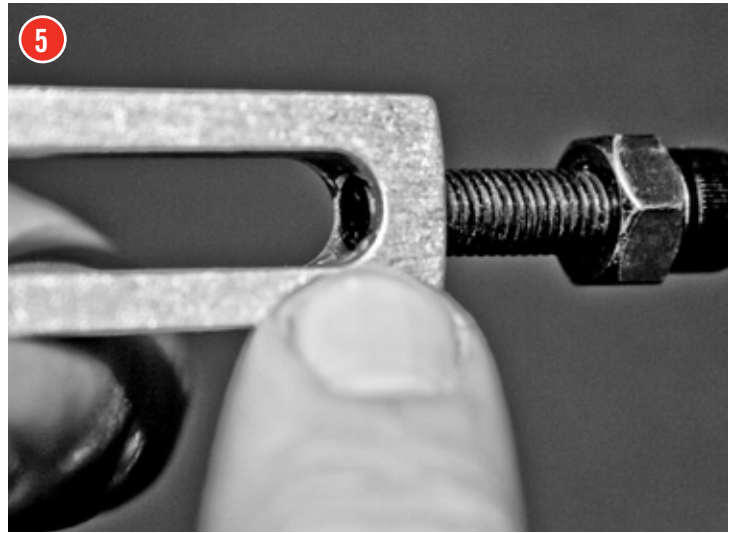

6 Unscrew the other cap screw until approximately two threads are showing.

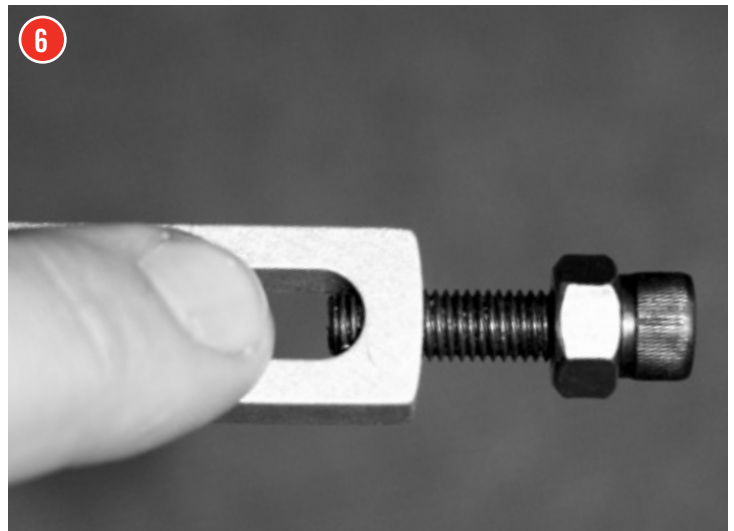

7 Install the PTX Powder Measure Stop over the hex spring mount with the cap screw that is protruding on the top.



CHANGE-OVER

8 Place an empty, primed case into the station of the shell plate that will rotate to the powder measure. Raise the ram which will cycle the powder measure to the top of its stroke. Thread the bottom cap screw in until the threaded end bottoms out on the lower hex spring mount.

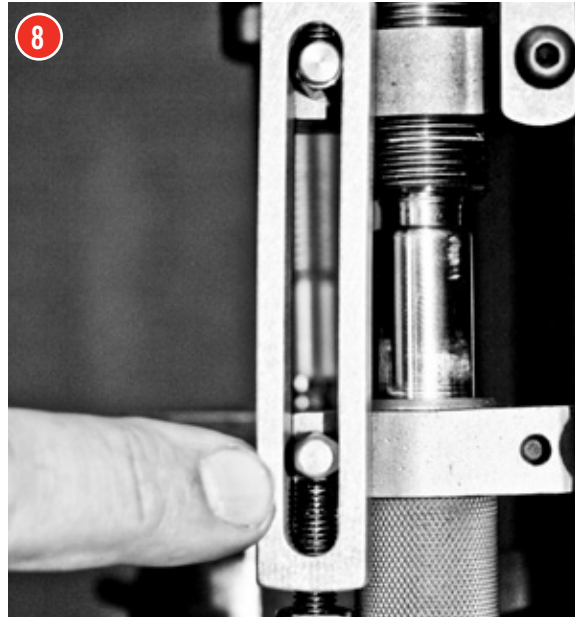

9 Lower the ram and replace the vertical spring on the hex spring mount.

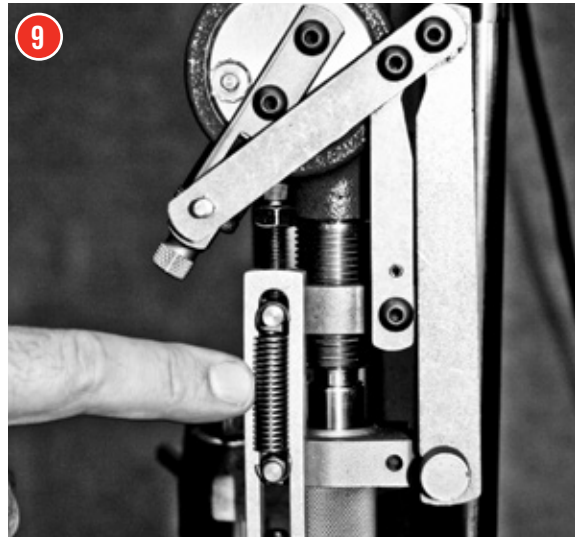

10 To adjust for more case mouth flare, continue to screw in the bottom cap screw, for less case mouth flare, back it out. Make small adjustments.

When adjusted as desired, tighten jam nuts to lock in adjustment.



Setup / Changeover of the Lock-N-Load® Case Feeder

The Hornady Lock-N-Load® Case Feeder is capable of feeding both pistol and rifle cases. When changing cartridges, the following components on the Case Feeder may need to be changed or verified.

- Feed Plate
- Feed Tube
- Feed Tube End
- Pivot Adapter/Pivot Adapter Bushing
- Drop Tube
- V-Block
- Adjustment the Cam Wire
- Case Feed Door Adjustment

Refer to the chart below to determine the correct components needed to operate the Lock-N-Load® Case Feeder. Caliber specific sizing can be found on the charts on pages 51-54.

Changing Feed Plate

Remove the existing Feed Plate by pulling straight up on the feed wheel to lift it off the motor drive shaft. To install the new plate, place Feed Plate over the motor shaft and rotate until pawls on motor shaft engage the two slots on the bottom of the Feed Plate.

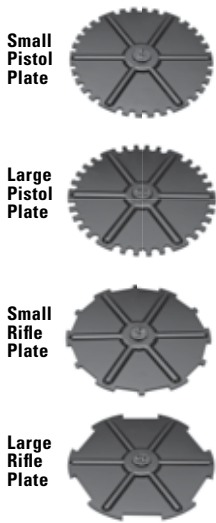

	Base Diameter	Feed Tube	Feed Tube End Insert	Feed Plate	Pivot Adapter Bushing	Drop Tube
Small Pistol Plate (9mm, 40 S&W, etc.)	<0.40"	SM - #14	Sm - #50	Sm Pistol #54 No. 095310	N/A	#53
	0.40" - .43"	LG - #13	Int - #73			
Large Pistol Plate (357 Mag, 44 Mag, etc.)	>0.43"	LG - #13	-NONE- Feed Tube End Primary Only	Lg Pistol #55 No. 095312	N/A	#22
Small Rifle Plate (223 Rem, 22 Hornet, etc.)	<0.43"	SM - #14	Sm - #50	Sm Rifle #56 No. 095314	#18 & #51 or #52	#53
Large Rifle Plate (243 Win, 45-70 Govt, etc.)	>0.43"	LG - #13	-NONE- Feed Tube End Primary Only	Lg Rifle #57 No. 095316	N/A	#22

If the Feed Tube, Feed Tube End, Pivot Adapter, Pivot Adapter Bushing, or Drop Tube need to be changed; remove those items and refer to **Assembly: Case Feeder starting on Page 18.**

Determining the size of the Clear Feed Tube

The base or rim diameter of the cartridge case determines the size of the feed tube. In general, a case smaller than .43" in diameter will use the Small Tube and Small Tube Adapter. Cases larger than 0.43" will utilize the Large Feed Tube only.

Exception: 40 S&W and 10mm Auto will use the Intermediate Feed Tube Insert (73) with the Large Feed Tube (13).

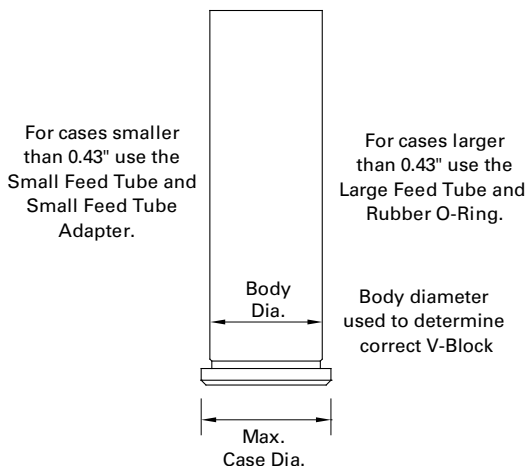

V-Block	Case Body Diameter
1	.27" - .30"
2	.37" - .39"
3	.35" - .38"
4	.42" - .47"
5	.46" - .58"
6	.41" - .44"

Determining the use of the Pivot Adapter and/or Pivot Adapter Bushing (Rifle Cases Only)

The Pivot Adapter is used with rifle cases to help guide the taller cases. You may also need to use the Pivot Adapter Bushing for rifle cases with a smaller base diameter (i.e. 223 Rem.).

Determining the correct Drop Tube

In general, the Drop Tube helps guide the case onto the press sub-plate. Again, a case smaller than .43" in diameter will use the Small Drop Tube, and cases larger than 0.43" will utilize the Large Drop Tube.

CHANGE-OVER

1 Replacing the V-Block

Refer to the chart and diagram on page 45 to determine the correct V-Block.

With the ram at the bottom of the stroke (idle position), set the V-Block onto the Case Slide.

Place the #10-24 X 1/2 Cap Screw through the hole of the V-Block and screw it into the Case Slide. Before you tighten the Cap Screw, push the V-Block back into the Case Slide and snug the Cap Screw with your fingers.

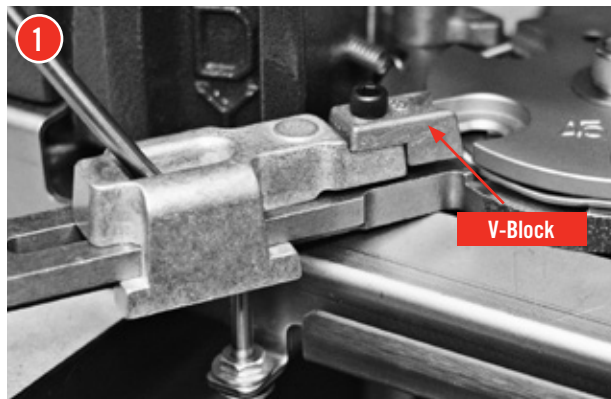

2 Place a case of the proper size into the shell plate and manually push the Case Slide and V-Block into the case.

Loosen the Cap Screw and continue to push the Case Slide into the case. Tighten the Cap Screw) with a 3/16" Allen wrench.

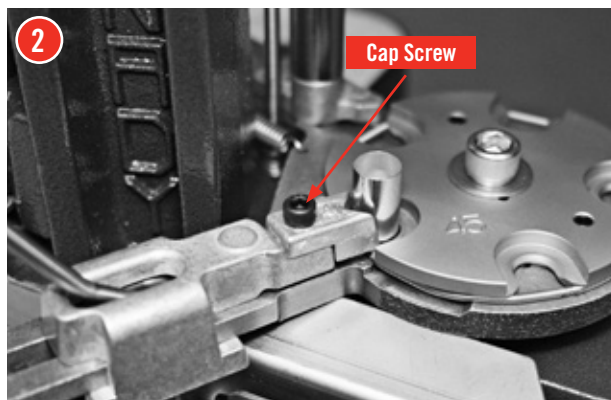

3 Raise the ram until the shell plate rotates and place a case (of the proper size) in front of the V-Block on the Sub-Plate. Lower the ram so the Case Slide will advance the case into the shell plate.

4 Adjusting the Cam Wire

The Cam Wire determines the timing of the Case Feed Slide and must be adjusted to allow the case to easily slide into the shell plate.

To adjust the Cam Wire, loosen both nuts so the wire can be moved either up or down.

If the cases are not fully seating into the shell plate, raise the Cam Wire.

If the cases are hitting the shell plate when feeding, or the shell plate cannot rotate, lower the Cam Wire.

Once the timing is correct, snug both nuts to the bracket and make sure the cam is centered in the Slide. This can be adjusted manually by rotating it a small amount around the threaded end. Tighten the nuts to complete the timing process. This timing setting is adequate for all cartridges and it should not be necessary to make future changes.

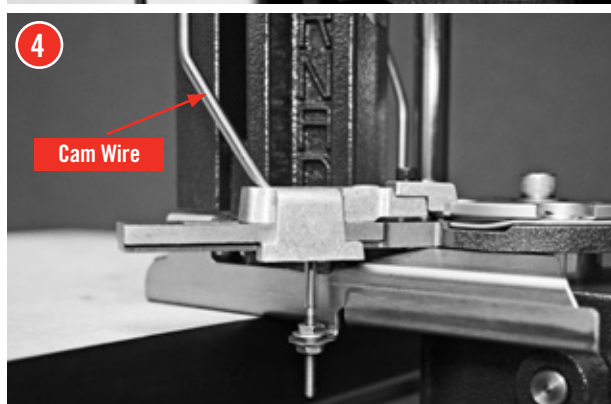

5 Case Feed Door Adjustments

The Case Feed Door is used to prevent cases from falling down the Drop Tube mouth first.

If loading pistol cases, the Case Feed Door should be opened completely by loosening the Button Head Screw with a 1/8" Hex Wrench. Re-tighten screw after completely opening the Case Feed Door.

If you are loading rifle cartridges, the length and weight of your cartridge will determine how far the door must be opened. This may take some trial and error.

Loosen the Button Head Cap Screw and slide the Case Feed Door Adjustment so the opening is approximately $\frac{3}{4}$ the length of the case. This is a preliminary setting. Place a hand-full of cases into the Case Feed Bowl, and turn on the Case Feeder

Observe to see if the cases will fall base first. If they do not, readjust the Case Feed Bowl Door Adjustment until they do without hanging up or getting caught. Re-tighten the Button Head Cap Screw.

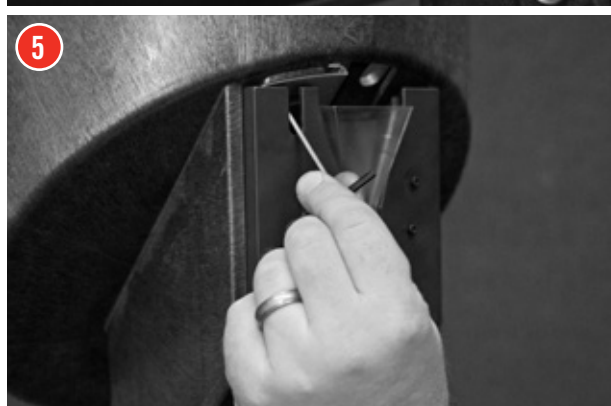

Setup / Changeover of the Lock-N-Load® Pistol Bullet Feeder

The Hornady® Lock-N-Load® Pistol Bullet Feeder is capable of feeding most pistol bullets. When changing bullet caliber, type, or brand, the following components on the Bullet Feeder may need to be changed or verified. Hopper Plate Height.

- Bottom Wiper Location
- Top Wiper Location
- Drop Tube Funnel
- Drop Tube
- Bullet Feeder Dies

1 Hopper Plate Height

Loosen ¼-20 Thumb Screw and the Lock Nut on the Adjustment Screw.

Raise the Bullet Guide Plate by turning the Adjustment Screw clockwise.

Raise the Bullet Guide Plate above the bottom of the slots on the Bullet Feed Wheel Pistol far enough to hold a bullet base first against the Bullet Feed Wheel Pistol.

- 2 Place two bullets onto the Bullet Feed Wheel, one with the nose toward the center, and the other with the base toward the center. Rotate the Adjustment Screw to adjust the Bullet Guide Plate either up or down to get a the nose down bullet to fall off the plate, yet keep the base down bullet on the Bullet Guide Plate.

Once the Bullet Guide Plate position is acceptable, tighten the Lock Nut and then the ¼-20 Thumb Screw.

3 Adjusting the Bottom Wiper

The bottom wiper is used to remove the top bullet when two bullets are double-stacked on the Feed Wheel Plate.

To adjust the spring location, loosen the two Wing Nuts and slide the assembly in or out. The spring should be located so the top bullet is knocked off the bottom bullet as the Bullet Feed Wheel turns. Tighten down the two wing nuts and the thumb screw.

Loosen the thumb screw and move the spring so that it just clears the Bullet Feed Wheel. The spring should not contact the Feed Wheel Plate during normal operation.

With a little trial and error, the spring should be adjusted so that it knocks off the top bullet without disturbing the bottom bullet.

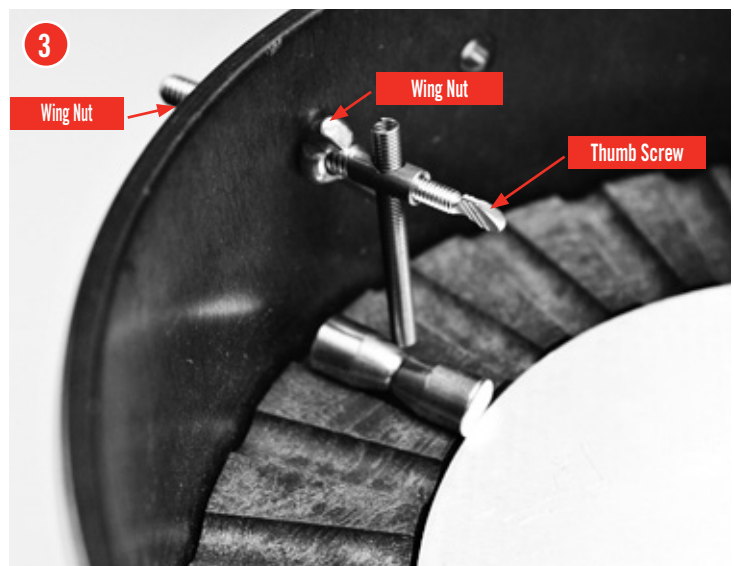
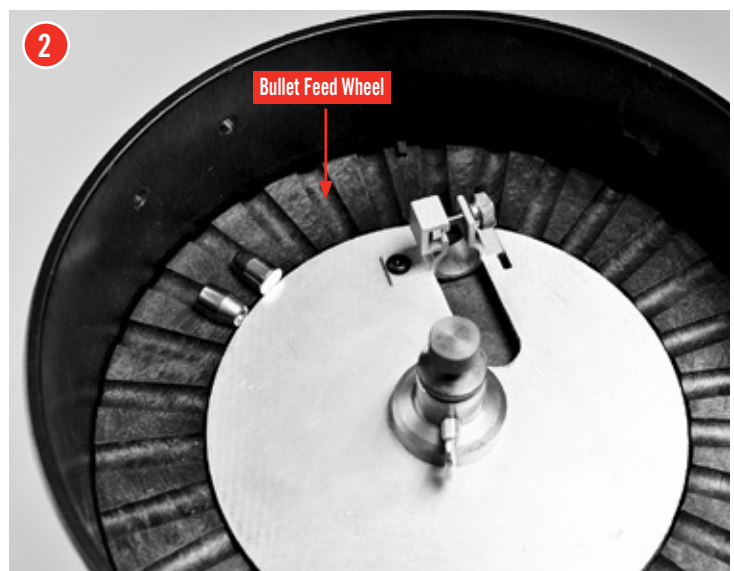
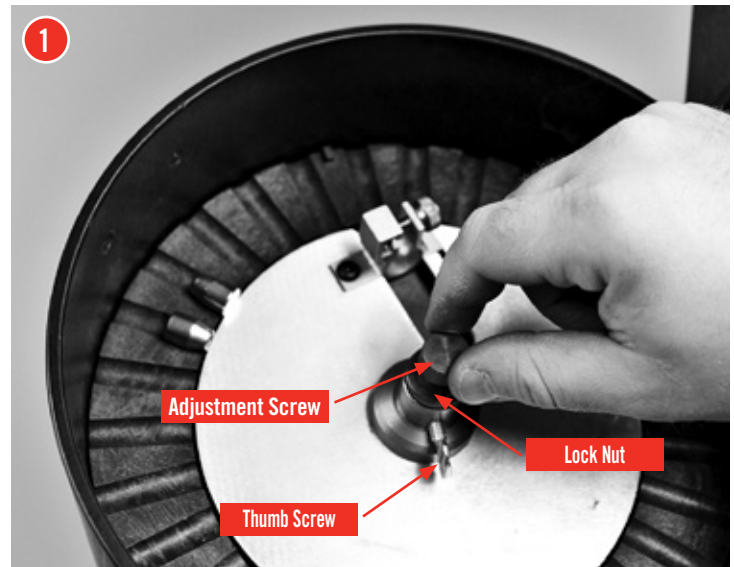

4 Adjusting the Top Wiper

The Top Wiper is intended to remove nose heavy bullets that do not fall off when pointed nose down on the Bullet Feed Plate .

Place two bullets onto the Bullet Feed Wheel near the Top Wiper, one with the nose toward the center, and the other with the base toward the center. Push the nose down a little on the bullet that is nose toward so the base is sticking up.

Adjust the second wiper spring and wiper screw to just miss the nose of the first bullet but kick the base of the second bullet.

Tighten down the two wing nuts and the thumb screw.

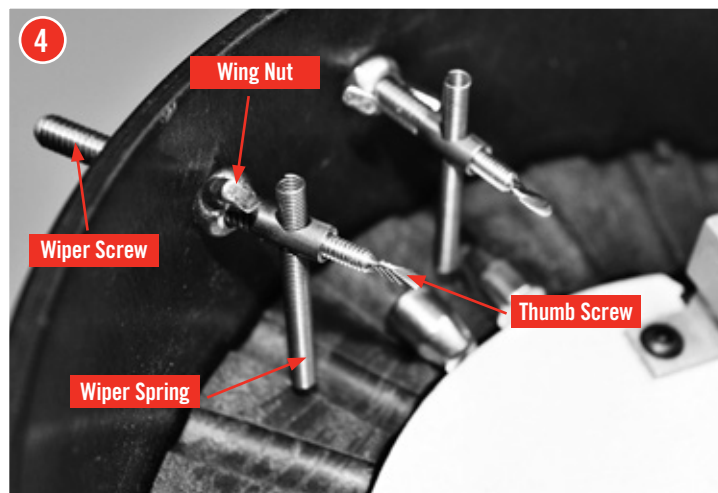

5 Switching Drop Tube Funnel

Select the correct size of Drop Funnel for your application.

9MM/38/.357 (375 I.D.)Item No. 399216
 40 S&W/10 MM (406 I.D.)Item No. 399215
 .44/.451/.452 (530 I.D.)Item No. 399214

Insert the Drop Funnel into Tube Spring Clamp. You will want the front edge (outside edge) of the Drop Funnel as close to the Bullet Feed Wheel Pistol without touching the Bullet Feed Wheel Pistol.

Tighten the Knurled Thumb Screw on the side of the Tube Spring Clamp. Only snug this screw, DO NOT over tighten this screw.

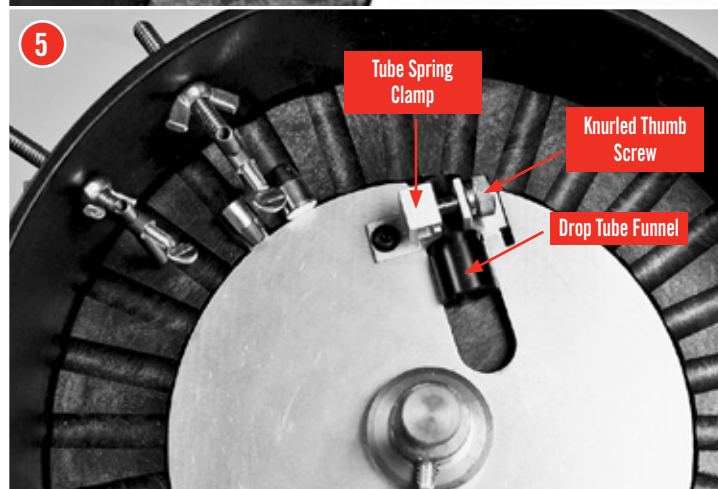

6 Switching the Drop Tube

Select the correct size of Drop Tube for your application.

9MM/38/.357 (375 I.D.)Item No. 399219
 40 S&W (406 I.D.)Item No. 399243
 .44/.451/.452 (530 I.D.)Item No. 399221

Slip the Drop Tube into the hole on the bottom right side of the Bullet Feed Hopper. Insert the end of the Drop Tube into the back end of the Drop Funnel. Insert the straight end of the Drop Tube Holder into the hole on the bottom right side of the hopper. Next place the Drop Tube into the hook of Drop Tube Holder.

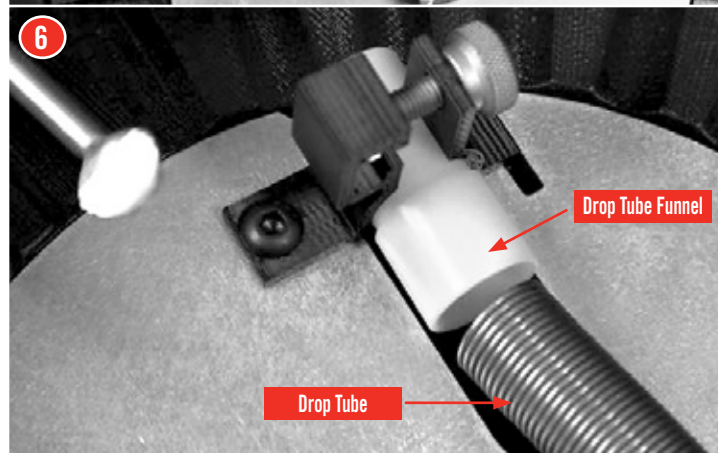

7 Testing Hopper Setup

At this time, place about 100 bullets into the Bullet Feed Hopper and turn on the Switch on the bottom right corner of the Bullet Feed Hopper.

You will want to hold the end of the Drop Tube in your hand at this time to catch the bullets that will fall out of the tube.

At this time, make sure you have the Bullet Wipers set correctly. If they are not, shut off the Switch and readjust the Bullet Wipers. You may need to do this a couple of times, until you have them set correctly and the bullets are falling base first every time.

If the hopper plate is jumping or not rotating smoothly, your Drop Tube Funnel is too close to the Bullet Feed Wheel Pistol. This needs backed off until the Bullet Feed Wheel Pistol rotates smoothly.

If the bullets are feeding correctly, tighten down the Bullet Guide Plate Thumb Screw, and Snug Lock Nut.

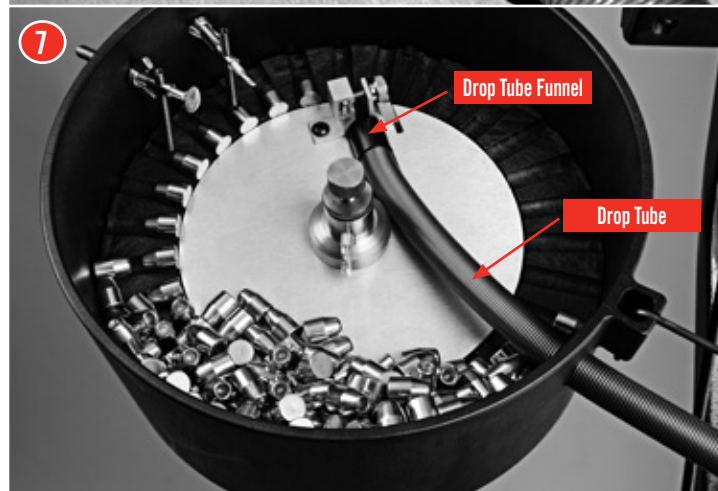

Bullet Feed Die Set Up

Disassemble the die and lay the parts out on a flat surface.

Degrease every part of the die.

Reassemble the die as you took it apart.

Collet "A" goes in first with the open slots facing the bottom of the die.

Collet "B" goes in next with the open slots facing the bottom of the die.

Thread the Lock Ring back onto the Adjustment Screw until the Lock Ring is near the top end of the Adjustment Screw.

Place the O-Ring over the threads of the Adjustment Screw until it is close to the Lock Ring.

Screw the Adjustment Screw into the die. Screw it down until the end of the Adjustment Screw is just touching "Collet B".

With the Adjustment Screw touching the top Collet, back the Adjustment Screw off ½ turn and lock down the Lock Ring against the top of the Die Body.

At this time you should be able to shake the die and hear the two Collets move up and down just a little bit. If you hear this, the die is set up correctly.

Die Adjustment Lock-N-Load® AP™

Screw on the Lock Ring to the outside threads of the Die Body.

Screw on the Lock-N-Load® Bushing to the outside threads of the Die Body.

Place the die into the top of the press and inserting it into the Lock-N-Load® Bushing in the Press Body.

Die Adjustment for a NON Lock-N-Load® AP™

Place a Flared Case for your set up in the previous station. Case mouths should be flared to the approximate dimensions listed below.

380/9MM385"
38/357387"
40S&W/10MM430"
44 SPL/44 MAG460"
.451/.452481"

Raise the ram to the top of the stroke.

Screw the Die Body down until it touches the top of the case.

Lower the ram to the bottom of the stroke.

Screw the Die Body down ½ turn and lock down the Lock Ring.

At this time the die should be set.

Place 5 or 6 bullets base first into the top of the die.

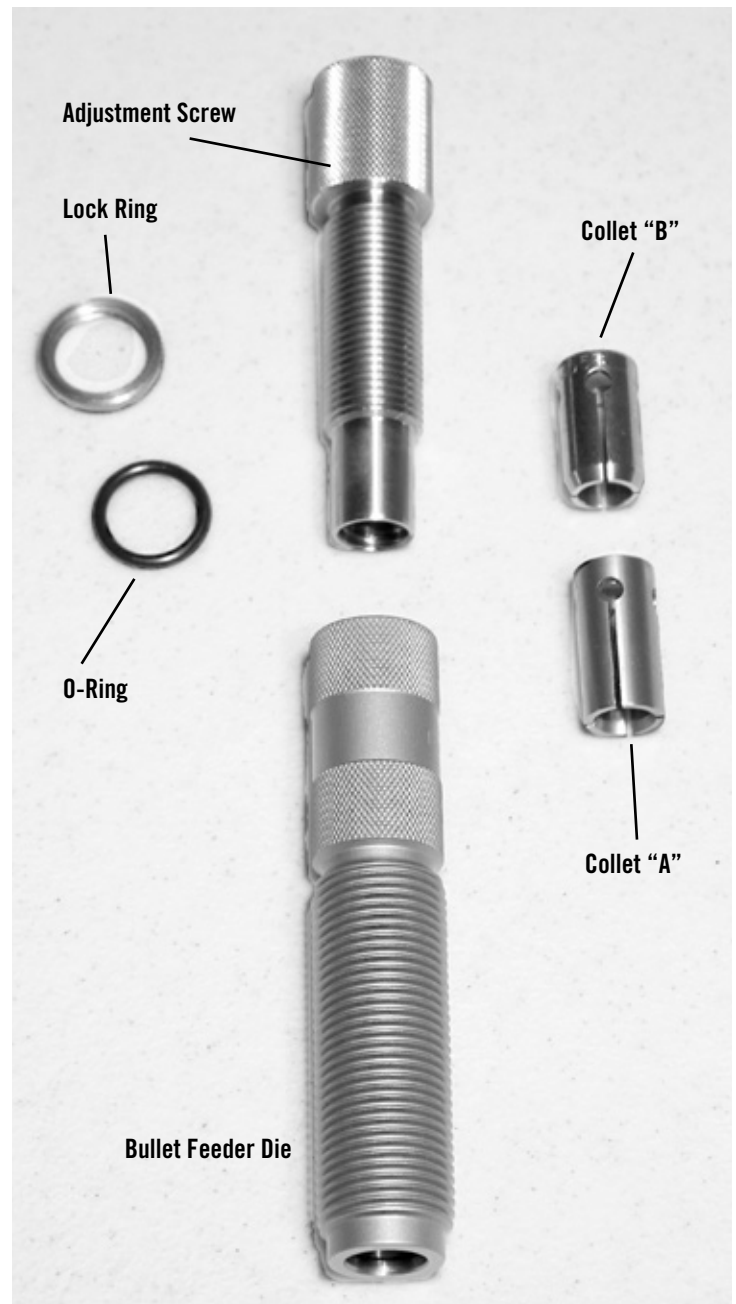

Die Set Up

Place the case into the Shell Plate in the station before the Bullet Feeder Die so when the press rotates, the Flared Case will be inserting into the Bullet Feeder Die. Continue to raise the Ram to the top of the stroke. You will not be able to see or hear anything at this time.

Lower the Ram slowly.

You should be able to see a bullet that dropped on top of the case mouth. If the bullet dropped onto the case mouth and you can see it, you should have been able to hear a little noise coming from the collets. This is a correct sound, it will do this every time that the collets work correctly.

If the collets didn't drop a bullet, lower the Die Body approximately 1/16" turn and repeat the previous 3 steps. Repeat these steps until you get a bullet to fall onto the case every time.

Troubleshooting the Lock-N-Load® Ammo Plant

Tips for Trouble-Free Operation of the Lock-N-Load® AP™ Press

Problems	Solutions
Powder dropping around case	<ul style="list-style-type: none"> • Correct bushing in place? • Powder drop tube and measure adapter clean? • Bushing installed deep counter sink side up?
No primer in case	<ul style="list-style-type: none"> • Primer slide properly adjusted? • Correct primer punch installed? • Primer slide spring in place? • Correct primer slide installed? • Primer body rotated counterclockwise when installed? • Primer housing tube too tight?
Shell Plate will not advance or does not index on station	<ul style="list-style-type: none"> • Primer not fully seated? • Pawls correctly adjusted? • Make sure you have the latest shell plate version with the groove on the bottom side.
Cases do not feed into Dies	<ul style="list-style-type: none"> • Die mouths beveled? (If not, return to manufacturer for repair.) • Pawls timed correctly?
Gun powder is sticking in the powder measure, or inconsistent charge weights	<ul style="list-style-type: none"> • Is the inside surface dry and clean? • Try pouring a little powdered graphite through the powder measure for lubricant. Rub the outside of the powder hopper with a dryer sheet to eliminate static.
Case retainer spring won't fall off the shell plate or it is getting kinked	<ul style="list-style-type: none"> • Is there a burr on the shell plate where the spring groove and the case location meet? • Is there a burr on the sides of the slot on the sub-plate? (With a case feeder, when you are setting up the timing, do not run the case into the spring if the spring is up on the shell plate.)
Cases are hitting the back corner of the shell plate when feeding into the shell plate	Slow timing down or readjust V-Block location
Cases are not feeding into the shell plate far enough	Speed timing up or using the wrong V-Block
Cases are tipping when going into the shell plate	Readjust V-Block location
Cases are falling on top of the V-Block	Readjust the bracket, square tubing
Drop tube is tight against the AP frame; will not allow changing of tubes	Readjust the bracket, square tubing
Cases are falling mouth first out of the bowl	Close the door adjustment
Cases are getting caught in the open hole on the bowl	Open the door adjustment
The shell plate is hitting the V-Block when it's rotating	Lower the cam wire

Shell Plate Troubleshooting

Problems	Solutions
Timing is severely out of adjustment	The Index Pawls may have been damaged
The Shell Plate does not rotate freely after mounting	<ul style="list-style-type: none"> • You may be trying to use the wrong version of shell plate. Your shell plate must have a groove cut on the bottom side. • Dirt or debris between the shell plate and the drive hub • The Ball Detent bodies are not below flush on the underside of the Shell Plate. • The Shell Plate is warped or damaged

*If you reach a point where you cannot get the press to work, please call our technical service staff at 800-338-3220 or send email to hornady.com/contact_us.

APPENDIX A

Rifle Dies & Reloading Essentials (Reference Chart)

Rifle Cartridge	Bullet Diameter (inches)	Die Set	Die Series	Full-Length Size Die	Seating Die	Expander Die	Taper Crimp Die Only	Neck Size Die	Shell Holder #/Item No.	Shell Plate #/Item No.	Case Feeder Plate Size / Item No.	Bullet Feeder Die	Trimmer/Pilot #/Item No.	Primer Punch	Bullet Puller Collet #/Item No.
17 HORNET	.172	546118	I	046202	044101	—	—	—	#3/390543	#3/392603	Sm Rfl/095314	—	*/390942	Small	#1/392154
17 REM FIREBALL	.172	546117	I	046200	044101	—	—	—	#16/390556	#16/392616	Sm Rfl/095314	—	*/390942	Small	#1/392154
17 REM	.172	546200	III	046201	044101	—	—	—	#16/390556	#16/392616	Sm Rfl/095314	—	*/390942	Small	#1/392154
17/222	.172	546202	IV	—	—	—	—	—	#16/390556	#16/392616	Sm Rfl/095314	—	*/390942	Small	#1/392154
17/223	.172	546204	IV	—	—	—	—	—	#16/390556	#16/392616	Sm Rfl/095314	—	*/390942	Small	#1/392154
20 VT	.204	546205	III	046206	044139	—	—	046038	#16/390556	#16/392616	Sm Rfl/095314	—	#22/390940	Small	#14/392167
20 TACTICAL	.204	546209	III	046208	044139	—	—	046038	#16/390556	#16/392616	Sm Rfl/095314	—	#22/390940	Small	#14/392167
204 RUGER	.204	546201	I	046590	044139	—	—	046038	#16/390556	#16/392616	Sm Rfl/095314	—	#22/390940	Small	#14/392167
22 HORNET	.224	546212	I	046213	044102	—	—	046066	#3/390543	#3/392603	Sm Rfl/095314	—	#1/390943	Small	#2/392155
22 K-HORNET	.224	546214	IV	—	—	—	—	046066	#3/390543	#3/392603	Sm Rfl/095314	—	#1/390943	Small	#2/392155
5.7x28 FN	.224	546203	III	046212	044136	—	—	—	#37/390577	—/—	Sm Rfl/095314	—	#1/390943	Small	#2/392155
218 BEE	.224	546206	IV	—	—	—	—	046066	#7/390547	#7/392607	Sm Rfl/095314	—	#1/390943	Small	#2/392155
221 REM FIREBALL	.224	546210	III	046211	044102	—	—	046040	#16/390556	#16/392616	Sm Rfl/095314	—	#1/390943	Small	#2/392155
222 REM	.224	546224	I	046225	044102	—	—	046040	#16/390556	#16/392616	Sm Rfl/095314	—	#1/390943	Small	#2/392155
223 REM	.224	546228	I	046229	044102	—	—	046040	#16/390556	#16/392616	Sm Rfl/095314	095340	#1/390943	Small	#2/392155
223 REM MATCH	.224	—	—	544229	044102	—	—	544227	#16/390556	#16/392616	Sm Rfl/095314	095340	#1/390943	Small	#2/392155
22 PPC	.224	546216	IV	—	—	—	—	046053	#6/390546	#6/392606	Sm Rfl/095314	—	#1/390943	Small	#2/392155
5.6x50 MAG	.224	546234	IV	—	—	—	—	046040	#16/390556	#16/392616	Sm Rfl/095314	—	#1/390943	Small	#2/392155
219 ZIPPER	.224	546208	IV	—	—	—	—	046040	#2/390542	#2/392602	Lg Rfl/095316	—	#1/390943	Large	#2/392155
225 WIN	.224	546232	III	046233	044127	—	—	046040	#4/390544	#4/392604	Lg Rfl/095316	—	#1/390943	Large	#2/392155
224 WBY	.224	546230	IV	—	—	—	—	046040	#17/390557	—/—	Lg Rfl/095316	—	#1/390943	Large	#2/392155
22/250 REM	.224	546220	I	046221	044102	—	—	046040	#1/390541	#1/392601	Lg Rfl/095316	—	#1/390943	Large	#2/392155
22/250 ACKLEY IMP	.224	546219	IV	—	—	—	—	046040	#1/390541	#1/392601	Lg Rfl/095316	—	#1/390943	Large	#2/392155
220 SWIFT	.224	546222	I	046223	044127	—	—	046054	#4/390544	#4/392604	Lg Rfl/095316	—	#1/390943	Large	#2/392155
5.6x57	.224	546236	IV	—	—	—	—	—	#1/390541	#1/392601	Lg Rfl/095316	—	#1/390943	Large	#2/392155
223 WIN SS MAG	.224	546223	I	046558	044707	—	—	—	#35/390575	#35/392635	Lg Rfl/095316	—	#1/390943	Large	#2/392155
22/6MM	.224	546249	III	046238	044127	—	—	046054	#1/390541	#1/392601	Lg Rfl/095316	—	#1/390943	Large	#2/392155
22 SAV HP	.227	546240	IV	—	—	—	—	—	#2/390542	#2/390602	Lg Rfl/095316	—	#2/390944	Large	#2/392155
5.6x52R	.227	546238	IV	—	—	—	—	—	#2/390542	#2/390602	Lg Rfl/095316	—	#2/390944	Large	#2/392155
6MM/223	.243	546248	IV	—	—	—	—	046047	#16/390556	#16/392616	Sm Rfl/095314	—	#3/390945	Small	#3/392156
6MM TCU	.243	546256	IV	—	—	—	—	046047	#16/390556	#16/392616	Sm Rfl/095314	—	#3/390945	Small	#3/392156
6x47 REM	.243	546258	IV	—	—	—	—	046047	#16/390556	#16/392616	Sm Rfl/095314	—	#3/390945	Small	#3/392156
6x47 LAPUA MATCH	.243	—	—	—	—	—	—	—	#1/390541	#16/392616	Sm Rfl/095314	—	#3/390945	Small	#3/392156
6MM PPC	.243	546254	IV	—	—	—	—	046052	#6/390546	#6/392606	Sm Rfl/095314	—	#3/390945	Small	#3/392156
6MM PPC MATCH	.243	—	—	544255	—	—	—	544253	#6/390546	#6/392606	Sm Rfl/095314	—	#3/390945	Small	#3/392156
6MM INT	.243	546252	IV	—	—	—	—	046041	#1/390541	#1/392601	Lg Rfl/095316	—	#3/390945	Large	#3/392156
6MM REM BR	.243	546432	IV	—	—	—	—	046047	#1/390541	#1/392601	Sm Rfl/095314	—	#3/390945	Small	#3/392156
6MM REM BR MATCH	.243	—	—	544251	—	—	—	544259	#1/390541	#1/392601	Sm Rfl/095314	—	#3/390945	Small	#3/392156
6MM HAGAR	.243	546303	IV	—	—	—	—	—	#12/390552	#12/392612	Sm Rfl/095314	—	#3/390945	Large	#3/392156
6MM CREEDMOOR	.243	546295	IV	—	—	—	—	046041	#1/390541	#1/392601	Lg Rfl/095316	—	#3/390945	Large	#3/392156
243 WIN	.243	546244	I	046245	044103	—	—	046041	#1/390541	#1/392601	Lg Rfl/095316	—	#3/390945	Large	#3/392156
244/6MM REM	.243	546246	I	046247	044103	—	—	046041	#1/390541	#1/392601	Lg Rfl/095316	—	#3/390945	Large	#3/392156
6MM/284	.243	546250	IV	—	—	—	—	046041	#1/390541	#1/392601	Lg Rfl/095316	—	#3/390945	Large	#3/392156
240 WBY	.243	546242	IV	—	—	—	—	046041	#1/390541	#1/392601	Lg Rfl/095316	—	#3/390945	Large	#3/392156
243 WIN SS MAG	.243	546225	I	046557	—	—	—	—	#35/390575	#35/392635	Lg Rfl/095316	—	#3/390945	Large	#3/392156
25/20 WIN	.257	546264	IV	—	—	—	—	—	#7/390547	#7/392607	Sm Rfl/095314	—	#4/390946	Small	#4/392157
256 WIN	.257	546272	IV	—	—	—	—	—	#6/390546	#6/392606	Sm Rfl/095314	—	#4/390946	Large	#4/392157
25/35 WIN	.257	546266	IV	—	—	—	—	—	#2/390542	#2/392602	Lg Rfl/095316	—	#4/390946	Large	#4/392157
25 REM	.257	546260	III	046276	044104	—	—	—	#12/390552	#12/392612	Lg Rfl/095316	—	#4/390946	Large	#4/392157
250 SAV	.257	546270	IV	—	—	—	—	046042	#1/390541	#1/392601	Lg Rfl/095316	—	#4/390946	Large	#4/392157
257 ROBERTS	.257	546274	III	046275	044104	—	—	046042	#1/390541	#1/392601	Lg Rfl/095316	—	#4/390946	Large	#4/392157
25 WIN SS MAG	.257	546263	IV	—	—	—	—	—	#35/390575	#35/392635	Lg Rfl/095316	—	#4/390946	Large	#4/392157
25/06 REM	.257	546262	I	046263	044104	—	—	046042	#1/390541	#1/392601	Lg Rfl/095316	—	#4/390946	Large	#4/392157
25/284	.257	546268	IV	—	—	—	—	046042	#1/390541	#1/392601	Lg Rfl/095316	—	#4/390946	Large	#4/392157
257 WBY	.257	546276	III	046277	044104	—	—	046042	#5/390545	#5/392605	Lg Rfl/095316	—	#4/390946	Large	#4/392157
6.5MMx47 MATCH	.264	544650	—	—	—	—	—	—	#1/390541	—/—	—/—	—	#5/390947	Small	#4/392157
6.5MM TCU	.264	546296	IV	—	—	—	—	046048	#16/390556	#16/392616	Sm Rfl/095314	—	#5/390947	Small	#4/392157
6.5 GRENDL	.264	546291	I	046598	044164	—	—	—	#6/390546	#6/392606	Sm Rfl/095314	—	#5/390947	Large	#4/392157
6.5 JAP	.264	546290	III	046291	044106	—	—	046043	#34/390574	—/—	Lg Rfl/095316	—	#5/390947	Large	#4/392157
6.5 JDJ	.264	—	—	—	—	—	—	046043	#4/390544	#4/392604	Lg Rfl/095316	—	#5/390947	Large	#4/392157
6.5 MANN/SCH.	.264	546292	IV	—	—	—	—	046043	#20/390560	—/—	Lg Rfl/095316	—	#5/390947	Large	#4/392157
6.5x55/SCAN.	.264	546282	I	046283	044106	—	—	046043	#19/390559	#19/392619	Lg Rfl/095316	—	#5/390947	Large	#4/392157
260 REM	.264	546269	III	046441	044106	—	—	046043	#1/390541	#1/392601	Lg Rfl/095316	—	#5/390947	Large	#4/392157
6.5 CREEDMOOR	.264	546289	I	046596	044106	—	—	046043	#1/390541	#1/392601	Lg Rfl/095316	—	#5/390947	Large	#4/392157
6.5 CREEDMOOR MATCH	.264	544655	—	—	—	—	—	—	#1/390541	#1/392601	Lg Rfl/095316	—	#5/390947	Large	#4/392157
6.5x57	.264	546284	III	046285	044106	—	—	046043	#1/390541	#1/392601	Lg Rfl/095316	—	#5/390947	Large	#4/392157
6.5/284	.264	546301	III	046443	044106	—	—	046043	#1/390541	#1/392601	Lg Rfl/095316	—	#5/390947	Large	#4/392157
6.5/06	.264	546280	III	046281	044123	—	—	046043	#1/390541	#1/392601	Lg Rfl/095316	—	#5/390947	Large	#4/392157

APPENDIX A

Rifle Dies & Reloading Essentials (Reference Chart)

Rifle Cartridge	Bullet Diameter (inches)	Die Set	Die Series	Full-Length Size Die	Seating Die	Expander Die	Taper Crimp Die Only	Neck Size Die	Shell Holder # / Item No.	Shell Plate # / Item No.	Case Feeder Plate Size / Item No.	Bullet Feeder Die	Trimmer Pilot # / Item No.	Primer Punch	Bullet Puller Collet # / Item No.
6.5 REM MAG	.264	546294	IV	—	—	—	—	046043	#5 / 390545	#5 / 392605	Lg Rfl / 095316	—	#5 / 390947	Large	#4 / 392157
264 WIN MAG	.264	546278	III	046279	044123	—	—	046043	#5 / 390545	#5 / 392605	Lg Rfl / 095316	—	#5 / 390947	Large	#4 / 392157
6.5x68	.264	546286	III	046287	044123	—	—	046043	#30 / 390570	#30 / 392630	Lg Rfl / 095316	—	#5 / 390947	Large	#4 / 392157
6.5 CARC	.268	546288	III	046289	044134	—	—	046043	#21 / 390561	— / —	Lg Rfl / 095316	—	#5 / 390947	Large	#4 / 392157
6.8MM REM SPC	.277	546299	III	046711	044713	—	—	—	#12 / 390552	#12 / 392612	Lg Rfl / 095316	—	#6 / 390948	Small	#5 / 392158
270 REN	.277	—	—	—	—	—	—	—	#3 / 390543	#3 / 392603	Sm Rfl / 095314	—	#6 / 390948	Small	#5 / 392158
270 WIN	.277	546300	I	046301	044107	—	—	046051	#1 / 390541	#1 / 392601	Lg Rfl / 095316	—	#6 / 390948	Large	#5 / 392158
270 WIN SHORT MAG	.277	546297	I	046450	044161	—	—	046055	#35 / 390575	#35 / 392635	Lg Rfl / 095316	—	#6 / 390948	Large	#5 / 392158
270 WBY	.277	546298	III	046299	044107	—	—	046051	#5 / 390545	#5 / 392605	Lg Rfl / 095316	—	#6 / 390948	Large	#5 / 392158
7MM /223 INGRAM	.284	546318	IV	—	—	—	—	046049	#16 / 390556	#16 / 392616	Sm Rfl / 095314	—	#7 / 390949	Small	#6 / 392159
7MM TCU	.284	546328	IV	—	—	—	—	046049	#16 / 390556	#16 / 392616	Sm Rfl / 095314	—	#7 / 390949	Small	#6 / 392159
7x47 HELM	.284	546306	IV	—	—	—	—	046049	#16 / 390556	#16 / 392616	Sm Rfl / 095314	—	#7 / 390949	Large	#6 / 392159
7MM REM BR	.284	546324	IV	—	—	—	—	046049	#1 / 390541	#1 / 392601	Sm Rfl / 095314	—	#7 / 390949	Large	#6 / 392159
7x30 WATERS	.284	546304	IV	—	—	—	—	046049	#13 / 390542	#13 / 392602	Lg Rfl / 095316	—	#7 / 390949	Large	#6 / 392159
7MM MERRILL	.284	546322	IV	—	—	—	—	046044	#4 / 390544	#4 / 392604	Lg Rfl / 095316	—	#7 / 390949	Large	#6 / 392159
7MM /08 REM	.284	546316	I	046317	044108	—	—	046044	#1 / 390541	#1 / 392601	Lg Rfl / 095316	—	#7 / 390949	Large	#6 / 392159
7x57-7MM MAUSER	.284	546308	I	046309	044108	—	—	046044	#1 / 390541	#1 / 392601	Lg Rfl / 095316	—	#7 / 390949	Large	#6 / 392159
7x57R	.284	—	—	—	—	—	—	046044	#13 / 390553	#13 / 392613	Lg Rfl / 095316	—	#7 / 390949	Large	#6 / 392159
284 WIN	.284	546302	III	046303	044108	—	—	046044	#1 / 390541	#1 / 392601	Lg Rfl / 095316	—	#7 / 390949	Large	#6 / 392159
280 REM /7MM EXP	.284	546320	I	046321	044108	—	—	046044	#1 / 390541	#1 / 392601	Lg Rfl / 095316	—	#7 / 390949	Large	#6 / 392159
280 ACKLEY IMP	.284	546321	III	046304	044108	—	—	046044	#1 / 390541	#1 / 392601	Lg Rfl / 095316	—	#7 / 390949	Large	#6 / 392159
7x65R	.284	546314	III	046315	044133	—	—	046044	#13 / 390553	#13 / 392613	Lg Rfl / 095316	—	#7 / 390949	Large	#6 / 392159
7x61 S&H	.284	546310	IV	—	—	—	—	046044	#35 / 390575	#35 / 392635	Lg Rfl / 095316	—	#7 / 390949	Large	#6 / 392159
7x64	.284	546312	III	046313	044108	—	—	046044	#1 / 390541	#1 / 392601	Lg Rfl / 095316	—	#7 / 390949	Large	#6 / 392159
7MM REM SA ULTRA MAG	.284	546309	III	046452	044108	—	—	046056	#5 / 390545	#5 / 392605	Lg Rfl / 095316	—	#7 / 390949	Large	#6 / 392159
7MM REM MAG	.284	546326	I	046327	044108	—	—	046044	#5 / 390545	#5 / 392605	Lg Rfl / 095316	—	#7 / 390949	Large	#6 / 392159
7MM WIN SHORT MAG	.284	546327	I	046451	044108	—	—	046056	#35 / 390575	#35 / 392635	Lg Rfl / 095316	—	#7 / 390949	Large	#6 / 392159
7MM WBY	.284	546330	III	046331	044108	—	—	046044	#5 / 390545	#5 / 392605	Lg Rfl / 095316	—	#7 / 390949	Large	#6 / 392159
7MM STW	.284	546440	IV	—	—	—	—	046044	#5 / 390545	#5 / 392605	Lg Rfl / 095316	—	#7 / 390949	Large	#6 / 392159
7MM REM ULTRA MAG	.284	546307	III	046454	044133	—	—	046056	#5 / 390545	#5 / 392605	Lg Rfl / 095316	—	#7 / 390949	Large	#6 / 392159
7.35 CARC	.300	546332	IV	—	—	—	—	—	#21 / 390561	— / —	Lg Rfl / 095316	—	#8 / 390950	Large	#7 / 392160
30 M1 CARB	.308	546503	II	046504	044142	044505	—	—	#22 / 390562	#22 / 392622	Sm Rfl / 095314	—	#9 / 390951	Small	#7 / 392160
30 REM	.308	—	—	—	—	—	—	046050	#12 / 390552	#12 / 392612	Lg Rfl / 095316	—	#9 / 390951	Large	#7 / 392160
30 AAC /WHISPER	.308	546349	I	046459	044165	—	—	—	#16 / 390556	#16 / 392616	Sm Rfl / 095314	—	#9 / 390951	Small	#7 / 392160
30 HERRETT	.308	546334	IV	—	—	—	—	046050	#2 / 390542	#2 / 392602	Lg Rfl / 095316	—	#9 / 390951	Large	#7 / 392160
30 /30 WIN	.308	546342	I	046343	044111	—	—	046050	#2 / 390542	#2 / 392602	Lg Rfl / 095316	—	#9 / 390951	Large	#7 / 392160
30-30 ACKLEY IMP	.308	546345	IV	—	—	—	—	046050	#2 / 390542	#2 / 392602	Lg Rfl / 095316	—	#9 / 390951	Large	#7 / 392160
303 SAV	.308	546354	IV	—	—	—	—	046050	#33 / 390573	— / —	Lg Rfl / 095316	—	#9 / 390951	Large	#7 / 392160
300 SAV	.308	546348	III	046349	044111	—	—	046050	#1 / 390541	#1 / 392601	Lg Rfl / 095316	—	#9 / 390951	Large	#7 / 392160
30 MERRILL	.308	546338	IV	—	—	—	—	046050	#4 / 390544	#4 / 392604	Lg Rfl / 095316	—	#9 / 390951	Large	#7 / 392160
308 MARLIN EXP	.308	546357	I	046358	044111	—	—	046045	#27 / 390567	#27 / 392627	Lg Rfl / 095316	—	#9 / 390951	Large	#7 / 392160
7.5 SWISS (7.5X55)	.308	546360	III	046361	044111	—	—	046045	#2 / 390542	#2 / 392602	Lg Rfl / 095316	—	#9 / 390951	Large	#7 / 392160
7.5 SWISS K31	.308	546361	III	046362	044111	—	—	046045	#2 / 390604	— / —	Lg Rfl / 095316	—	#9 / 390951	Large	#7 / 392160
308 WIN	.308	546358	I	046359	044111	—	—	046045	#1 / 390541	#1 / 392601	Lg Rfl / 095316	095345	#9 / 390951	Large	#7 / 392160
308 WIN MATCH	.308	—	—	544359	—	—	—	544357	#1 / 390541	#1 / 392601	Lg Rfl / 095316	095345	#9 / 390951	Large	#7 / 392160
7.62 RUSS	.308	546362	III	046363	044111	—	—	046050	#23 / 390563	#23 / 392623	Lg Rfl / 095316	—	#9 / 390951	Large	#7 / 392160
30 /40 KRAG	.308	546344	IV	—	—	—	—	046045	#11 / 390551	#11 / 392611	Lg Rfl / 095316	—	#9 / 390951	Large	#7 / 392160
30 TC	.308	546335	I	046336	044111	—	—	046045	#1 / 390541	#1 / 392601	Lg Rfl / 095316	—	#9 / 390951	Large	#7 / 392160
30 /06	.308	546340	I	046341	044112	—	—	046045	#1 / 390541	#1 / 392601	Lg Rfl / 095316	—	#9 / 390951	Large	#7 / 392160
30 /06 ACKLEY IMP	.308	546341	IV	—	—	—	—	046045	#1 / 390541	#1 / 392601	Lg Rfl / 095316	—	#9 / 390951	Large	#7 / 392160
300 H&H	.308	546346	IV	—	—	—	—	046045	#5 / 390545	#5 / 392605	Lg Rfl / 095316	—	#9 / 390951	Large	#7 / 392160
300 OLYMPIC	.308	546355	IV	—	—	—	—	—	#35 / 390575	#35 / 392635	Lg Rfl / 095316	—	#9 / 390951	Large	#7 / 392160
300 REM SA ULTRA MAG	.308	546347	I	046455	044160	—	—	046057	#5 / 390545	#5 / 392605	Lg Rfl / 095316	—	#9 / 390951	Large	#7 / 392160
300 NORMA MAG	.308	546356	IV	—	—	—	—	046045	#5 / 390545	#5 / 392605	Lg Rfl / 095316	—	#9 / 390951	Large	#7 / 392160
300 WIN SHORT MAG	.308	546369	I	046453	044160	—	—	046057	#35 / 390575	#35 / 392635	Lg Rfl / 095316	—	#9 / 390951	Large	#7 / 392160
300 RCM	.308	546353	I	046592	044111	—	—	046045	#5 / 390545	#5 / 392605	Lg Rfl / 095316	—	#9 / 390951	Large	#7 / 392160
300 WIN MAG	.308	546352	I	046353	044112	—	—	046045	#5 / 390545	#5 / 392605	Lg Rfl / 095316	—	#9 / 390951	Large	#7 / 392160
300 WBY	.308	546350	I	046351	044112	—	—	046045	#5 / 390545	#5 / 392605	Lg Rfl / 095316	—	#9 / 390951	Large	#7 / 392160
300 REM ULTRA MAG	.308	546365	I	046447	044159	—	—	046057	#5 / 390545	#5 / 392605	Lg Rfl / 095316	—	#9 / 390951	Large	#7 / 392160
30 /378	.308	546419	IV	—	—	—	—	046057	#14 / 390554	#14 / 392614	Lg Rfl / 095316	—	#9 / 390951	Large	#7 / 392160
307 WIN	.308	—	—	—	—	—	—	046045	#33 / 390573	— / —	Lg Rfl / 095316	—	#9 / 390951	Large	#7 / 392160
309 JDJ	.308	—	—	—	—	—	—	046045	#27 / 390567	— / —	Lg Rfl / 095316	—	#9 / 390951	Large	#7 / 392160
7.62x39	.308	546424	I	046425	044126	—	—	—	#6 / 390546	#6 / 392606	Sm Rfl / 095314	—	#9 / 390951	Large	#7 / 392160
BLANK CART 22-45 CAL	—	544591	IV	—	—	—	—	—	— / —	— / —	— / —	—	— / —	—	— / —
32 /20 WIN	.311	546364	III	046365	044113	—	—	—	#7 / 390547	#7 / 392607	Sm Rfl / 095314	—	#9 / 390951	Small	#7 / 392160
7.65 BELG	.312	546368	III	046369	044114	—	—	—	#24 / 390564	— / —	Lg Rfl / 095316	—	#10 / 390952	Large	#7 / 392160
303 BRITISH	.312	546366	I	046367	044114	—	—	—	#11 / 390551	#11 / 392611	Lg Rfl / 095316	—	#10 / 390952	Large	#7 / 392160
7.7 JAP	.312	546370	III	046371	044114	—	—	—	#1 / 390541	#1 / 392601	Lg Rfl / 095316	—	#10 / 390952	Large	#7 / 392160

APPENDIX A

APPENDIX A

Rifle Dies & Reloading Essentials (Reference Chart)

Rifle Cartridge	Bullet Diameter (inches)	Die Set	Die Series	Full-Length Size Die	Seating Die	Expander Die	Taper Crimp Die Only	Neck Size Die	Shell Holder # / Item No.	Shell Plate # / Item No.	Case Feeder Plate Size / Item No.	Bullet Feeder Die	Trimmer Pilot # / Item No.	Primer Punch	Bullet Puller Collet # / Item No.
32/40 WIN	.321	546374	IV	—	—	—	—	—	#2/390542	#2/392602	Lg Rfl/095316	—	#11/390953	Large	#8/392161
32 WIN SPL	.321	546372	IV	—	—	—	—	—	#2/390542	#2/392602	Lg Rfl/095316	—	#11/390953	Large	#8/392161
32 REM	.321	—	—	—	—	—	—	—	#12/390552	#12/392612	Lg Rfl/095316	—	#12/390954	Large	#8/392161
7.92x33 KURZ	.323	546375	III	046376	044137	—	—	—	#1/390541	#1/392601	Sm Rfl/095314	—	#11/390953	Large	#8/392161
8MM MAUS	.323	546382	I	046383	044116	—	—	—	#1/390541	#1/392601	Lg Rfl/095316	—	#11/390953	Large	#8/392161
8x60S	.323	546376	III	046377	044116	—	—	—	#1/390541	#1/392601	Lg Rfl/095316	—	#11/390953	Large	#8/392161
8MM/06	.323	546380	IV	—	—	—	—	—	#1/390541	#1/392601	Lg Rfl/095316	—	#11/390953	Large	#8/392161
8x50R LABEL	.323	546383	IV	—	—	—	—	—	#49/390605	—/—	Lg Rfl/095316	—	#11/390953	Large	#8/392161
325 WSM	.323	546387	IV	—	—	—	—	—	#35/390575	#35/392635	Lg Rfl/095316	—	#11/390953	Large	#8/392161
8x68S	.323	546378	IV	—	—	—	—	—	#30/390570	#30/392630	Lg Rfl/095316	—	#11/390953	Large	#8/392161
8MM REM MAG	.323	546384	IV	—	—	—	—	—	#5/390545	#5/392605	Lg Rfl/095316	—	#11/390953	Large	#8/392161
8.15X46R	.324	546386	IV	—	—	—	—	—	#2/390542	#2/392602	Lg Rfl/095316	—	#11/390953	Large	#8/392161
8x56 HUNGARIAN-MANN	.329	546385	IV	—	—	—	—	—	#47/390603	—/—	Lg Rfl/095316	—	#11/390953	Large	#8/392161
33 WIN	.338	546388	IV	—	—	—	—	046058	#14/390554	#14/392614	Lg Rfl/095316	—	#13/390955	Large	#9/392162
338 FEDERAL	.338	546397	III	046595	044131	—	—	046058	#1/390541	#1/392601	Lg Rfl/095316	—	#13/390955	Large	#9/392162
338 MARLIN EXPRESS	.338	546359	I	046597	044131	—	—	046058	#52/390607	#52/392652	Lg Rfl/095316	—	#13/390955	Large	#9/392162
338 NORMA MAG	.338	—	—	—	—	—	—	046058	#43/390583	—/—	Lg Rfl/095316	—	#13/390955	Large	#9/392162
338/06	.338	546395	IV	—	—	—	—	046058	#1/390541	#1/392601	Lg Rfl/095316	—	#13/390955	Large	#9/392162
338 RCM	.338	546399	I	046594	044131	—	—	046058	#5/390545	#5/392605	Lg Rfl/095316	—	#13/390955	Large	#9/392162
338 WIN MAG	.338	546390	I	046391	044117	—	—	046058	#5/390545	#5/392605	Lg Rfl/095316	—	#13/390955	Large	#9/392162
340 WBY	.338	546392	IV	—	—	—	—	046058	#5/390545	#5/392605	Lg Rfl/095316	—	#13/390955	Large	#9/392162
338 ULTRA MAG	.338	546389	III	046446	044117	—	—	046058	#5/390545	#5/392605	Lg Rfl/095316	—	#13/390955	Large	#9/392162
338 LAPUA	.338	546393	III	046593	044117	—	—	046058	#43/390583	—/—	Lg Rfl/095316	—	#13/390955	Large	#9/392162
338/378 WBY	.338	546391	IV	—	—	—	—	046058	#14/390554	#14/392614	Lg Rfl/095316	—	#13/390955	Large	#9/392162
348 WIN	.348	546394	IV	—	—	—	—	—	#25/390565	—/—	Lg Rfl/095316	—	#14/390956	Large	#9/392162
35 REM	.358	546398	III	046399	044130	—	—	—	#26/390566	—/—	Lg Rfl/095316	—	#15/390957	Large	#9/392162
356 WIN	.358	—	—	—	—	—	—	046046	#33/390573	—/—	Lg Rfl/095316	—	#15/390957	Large	#9/392162
358 WIN	.358	546408	IV	—	—	—	—	046046	#1/390541	#1/392601	Lg Rfl/095316	—	#15/390957	Large	#9/392162
350 REM MAG	.358	546402	IV	—	—	—	—	—	#5/390545	#5/392605	Lg Rfl/095316	—	#15/390957	Large	#9/392162
35 WHELEN	.358	546400	III	046401	044119	—	—	046046	#1/390541	#1/392601	Lg Rfl/095316	—	#15/390957	Large	#9/392162
358 N MAG	.358	546406	IV	—	—	—	—	046046	#5/390545	#5/392605	Lg Rfl/095316	—	#15/390957	Large	#9/392162
9.3x57	.366	546410	III	046411	044120	—	—	—	#1/390541	#1/392601	Lg Rfl/095316	—	#20/390962	Large	#9/392162
9.3x74R	.366	546414	III	046415	044120	—	—	—	#13/390553	#13/392613	Lg Rfl/095316	—	#20/390962	Large	#9/392162
9.3x62	.366	546412	III	046413	044120	—	—	—	#1/390541	#1/392601	Lg Rfl/095316	—	#20/390962	Large	#9/392162
375 JDJ	.375	—	—	—	—	—	—	—	#27/390567	—/—	Lg Rfl/095316	—	#16/390958	Large	#10/392163
38/55 WCF	.375	546537	IV	—	—	—	—	—	#2/390542	#2/392602	Lg Rfl/095316	—	#16/390958	Large	#10/392163
375 WIN	.375	546530	IV	—	—	—	—	—	#2/390542	#2/392602	Lg Rfl/095316	—	#16/390958	Large	#10/392163
376 STEYR	.375	546417	IV	—	—	—	—	—	#15/390555	—/—	Lg Rfl/095316	—	#16/390958	Large	#10/392163
375 H&H	.375	546416	I	046417	044121	—	—	—	#5/390545	#5/392605	Lg Rfl/095316	—	#16/390958	Large	#10/392163
375 RUGER	.375	546415	I	046418	044121	—	—	—	#5/390545	#5/392605	Lg Rfl/095316	—	#16/390958	Large	#10/392163
375 REM ULTRA MAG	.375	546450	IV	—	—	—	—	—	#5/390545	#5/392605	Lg Rfl/095316	—	#16/390958	Large	#10/392163
378 WBY	.375	546418	IV	—	—	—	—	—	#14/390554	#14/392614	Lg Rfl/095316	—	#16/390958	Large	#10/392163
450/400 NE	.410	546421	IV	—	—	—	—	—	#54/390609	—/—	Lg Rfl/095316	—	#17/390959	Large	#11/392164
405 WIN	.411	546425	II	046456	044162	044571	—	—	#42/390582	—/—	Lg Rfl/095316	—	#17/390959	Large	#11/392164
10.3x60	.415	546420	IV	—	—	—	—	—	#25/390565	—/—	Lg Rfl/095316	—	#17/390959	Large	#11/392164
416 TAYLOR	.416	546427	IV	—	—	—	—	—	#5/390545	—/—	Lg Rfl/095316	—	#17/390959	Large	#11/392164
416 RIGBY	.416	546428	IV	—	—	—	—	—	#38/390578	—/—	Lg Rfl/095316	—	#17/390959	Large	#11/392164
416 RUGER	.416	546429	IV	—	—	—	—	—	#5/390545	#5/392605	Lg Rfl/095316	—	#17/390959	Large	#11/392164
416 REM MAG	.416	546426	IV	—	—	—	—	—	#5/390545	#5/392605	Lg Rfl/095316	—	#17/390959	Large	#11/392164
416 WBY	.416	546430	IV	—	—	—	—	—	#14/390554	#14/392614	Lg Rfl/095316	—	#17/390959	Large	#11/392164
404 JEFFERY	.423	546423	IV	—	—	—	—	—	#53/390608	—/—	Lg Rfl/095316	—	#17/390959	Large	#12/392165
444 MARLIN	.430	546551	II	046552	044149	044553	—	—	#27/390567	#27/392627	Lg Rfl/095316	—	#18/390960	Large	#12/392165
450 BUSHMASTER	.452	546452	V	046422	044721	044550	044176	—	#1/390541	#1/392601	Lg Rfl/095316	—	#19/390961	Large	#13/392166
458 SOCOM	.458	546464	III	046424	044190	—	—	—	#1/390541	#1/392601	Lg Rfl/095316	—	#19/390961	Small	#13/392166
45/70 GOVMT	.458	546566	II	046567	044152	044568	—	—	#14/390554	#14/392614	Lg Rfl/095316	—	#19/390961	Large	#13/392166
450 MARLIN	.458	546553	II	046587	044152	044568	—	—	#5/390545	#5/392605	Lg Rfl/095316	—	#19/390961	Large	#13/392166
450 NITRO EXPRESS	.458	546433	IV	—	—	—	—	—	#54/390609	—/—	N/A	—	#19/390961	Large	#13/392166
458 WIN MAG	.458	546569	II	046570	044153	044568	—	—	#5/390545	#5/392605	Lg Rfl/095316	—	#19/390961	Large	#13/392166
458 LOTT	.458	546465	II	046457	044153	044572	—	—	#5/390545	#5/392605	Lg Rfl/095316	—	#19/390961	Large	#13/392166
460 WBY	.458	546422	IV	—	—	—	—	—	#14/390554	#14/392614	Lg Rfl/095316	—	#19/390961	Large	#13/392166
470 NITRO EXPRESS	.474	546434	IV	—	—	—	—	—	#55/390610	—/—	N/A	—	#23/390939	Large	—/—
50/70 GOVT	.510	546462	IV	—	—	—	—	—	—/—	—/—	Lg Rfl/095316	—	#50/390937	Large	—/—
50 BEOWOLF	.500	—	—	—	—	—	—	—	#6/390546	#6/392606	Lg Rfl/095316	—	#50/390937	Large	—/—
50 ALASKAN	.510	546586	IV	—	—	—	—	—	#25/390565	—/—	Lg Rfl/095316	—	#50/390937	Large	—/—
500 NITRO EXPRESS	.510	546435	IV	—	—	—	—	—	#55/390610	—/—	N/A	—	#50/390937	Large	—/—

APPENDIX A

Pistol Dies & Reloading Essentials (Reference Chart)

Pistol Cartridge

	Bullet Diameter (inches)	Die Set	Die Series	Full-Length Size Die	Seating Die	Expander Die	Taper Crimp Seater Die	Taper Crimp Die Only	Shell Holder # / Item No.	Shell Plate # / Item No.	Case Feeder Plate Size / Item No.	Bullet Feeder Die	Trimmer Pilot # / Item No.	Primer Punch
22 RCFM-JET	.224	546218	IV	—	—	—	—	—	#6 / 390546	#6 / 392606	Sm Pstl / 095310	N/A	#1 / 390943	Small
25 AUTO	.251	—	—	—	—	—	—	—	#37 / 390577	— / —	Sm Pstl / 095310	N/A	#4 / 390946	Small
30 LUGER	.308	546336	IV	—	—	—	—	—	#8 / 390548	#8 / 392608	Sm Pstl / 095310	N/A	#9 / 390951	Small
30 MAUSER	.309	—	—	—	—	—	—	—	#8 / 390548	#8 / 392608	Sm Pstl / 095310	N/A	#9 / 390951	Small
32 AUTO	.311	546506	II	046507	044113	044508	—	—	#22 / 390562	#22 / 392622	Sm Pstl / 095310	N/A	#10 / 390952	Small
32 S&W LONG/H&R/ 327 FEDERAL	.311	546509	II	046510	044143	044511	—	—	#36 / 390576	#36 / 392636	Sm Pstl / 095310	N/A	#10 / 390952	Small
7.5 SWISS ORDEN	.312	546504	IV	—	—	—	—	—	#48 / 390604	— / —	Sm Pstl / 095310	N/A	#10 / 390952	Small
8MM LEBEL REV	.326	546510	IV	—	—	—	—	—	#48 / 390604	— / —	Lg Pstl / 095312	N/A	#11 / 390953	Large
380 AUTO	.355	546518	II	046519	044144	044517	—	044170	#16 / 390556	#16 / 392616	Sm Pstl / 095310	095330	#15 / 390957	Small
TAPER CRIMP 9MM/9x21	.355	546516	II	046516	044177	044517	044177	—	#8 / 390548	#8 / 392608	— / —	N/A	#15 / 390957	Small
9MM LUGER/9x21	.355	546515	II	046516	044144	044517	—	044170	#8 / 390548	#8 / 392608	Sm Pstl / 095310	095330	#15 / 390957	Small
357 SIG	.355	546575	II	046576	044144	044577	—	—	#10 / 390550	#10 / 392610	Sm Pstl / 095310	N/A	#15 / 390957	Small
9x23	.355	546532	IV	—	—	—	—	—	#8 / 390548	#8 / 392608	Sm Pstl / 095310	N/A	#15 / 390957	Small
38 S&W	.357	546521	IV	—	—	—	—	—	#28 / 390568	#28 / 392628	Lg Pstl / 095312	N/A	#15 / 390957	Large
38 SUPER AUTO	.357	546524	II	046525	044144	044526	—	—	#8 / 390548	#8 / 392608	Sm Pstl / 095310	N/A	#15 / 390957	Small
357 HERRETT	.357	546396	IV	—	—	—	—	—	#2 / 390542	#2 / 392602	Lg Pstl / 095312	N/A	#15 / 390957	Large
357 B&D/44	.358	546404	IV	—	—	—	—	—	#30 / 390570	#30 / 392630	Lg Pstl / 095312	N/A	#15 / 390957	Large
38 SPECIAL	.357	546527	II	046528	044145	044523	—	—	#6 / 390546	#6 / 392606	Lg Pstl / 095312	095331	#15 / 390957	Small
357 MAGNUM	.357	546527	II	046528	044145	044523	—	—	#6 / 390546	#6 / 392606	Lg Pstl / 095312	095331	#15 / 390957	Small
357 REM MAX	.357	546527	II	046528	044145	044523	—	—	#6 / 390546	#6 / 392606	Lg Pstl / 095312	095331	#15 / 390957	Small
COWBOY 38-357-357 MAX	.357	546528	III	046528	044591	044591	—	—	#8 / 390548	#8 / 392608	Lg Pstl / 095312	N/A	#15 / 390957	Small
9x18 MAKAROV	.364	546512	II	046513	044154	044514	—	—	#8 / 390548	#8 / 392608	Sm Pstl / 095310	N/A	#15 / 390957	Small
40 S&W	.400	546533	II	046534	044146	044535	—	044171	#10 / 390550	#10 / 392610	Sm Pstl / 095310	095332	#21 / 390941	Small
TAPER CRIMP 40 S&W	.400	546534	II	046534	044178	044535	044178	044171	#10 / 390550	#10 / 392610	Lg Pstl / 095312	N/A	#21 / 390941	Small
10MM AUTO	.400	546533	II	046534	044146	044535	—	044171	#10 / 390550	#10 / 392610	Lg Pstl / 095312	095332	#21 / 390941	Large
TAPER CRIMP 10MM	.400	546534	II	046534	044178	044535	044178	044171	#10 / 390550	#10 / 392610	Lg Pstl / 095312	N/A	#21 / 390941	Large
38/40 WIN	.400	546536	IV	—	—	—	—	—	#9 / 390549	#9 / 392609	Lg Pstl / 095312	N/A	#21 / 390941	Large
400 COR-BON	.400	546538	IV	—	—	—	—	—	#45 / 390606	#45 / 392645	Lg Pstl / 095312	N/A	#21 / 390941	Large
41 AE	.410	546539	II	046540	044147	044541	—	—	#29 / 390569	#29 / 392629	Lg Pstl / 095312	N/A	#17 / 390959	Small
41 REM MAG	.410	546539	II	046540	044147	044541	—	—	#29 / 390569	#29 / 392629	Lg Pstl / 095312	N/A	#17 / 390959	Large
COWBOY 44/40 WIN	.429	546543	III	046460	044166	044593	—	—	#9 / 390549	#9 / 392609	Lg Pstl / 095312	N/A	#18 / 390960	Large
44 AUTO MAG	.430	546545	IV	—	—	—	—	—	#1 / 390541	#1 / 392601	Lg Pstl / 095312	095333	#18 / 390960	Large
44 REM MAG	.430	546548	II	046549	044148	044544	—	—	#30 / 390570	#30 / 392630	Lg Pstl / 095312	N/A	#18 / 390960	Large
44 SPECIAL	.430	546548	II	046549	044148	044544	—	—	#30 / 390570	#30 / 392630	Lg Pstl / 095312	095333	#18 / 390960	Large
COWBOY 44 SPCL	.430	546549	III	046549	044166	044166	—	—	#30 / 390570	#30 / 392630	Lg Pstl / 095312	N/A	#18 / 390960	Large
445 SUPER MAG	.430	—	—	—	—	—	—	—	#30 / 390570	#30 / 392630	Lg Pstl / 095312	N/A	#18 / 390960	Large
45 AUTO	.451	546554	II	046555	044151	044556	—	044172	#45 / 390606	#45 / 392645	Lg Pstl / 095312	095334	#19 / 390961	Large
45 AUTO RIMMED	.451	546554	II	046555	044151	044556	—	044172	#31 / 390571	#31 / 392631	Lg Pstl / 095312	095334	#19 / 390961	Large
45 WIN MAG	.451	546554	II	046555	044151	044556	—	044172	#1 / 390541	#1 / 392601	Lg Pstl / 095312	095334	#19 / 390961	Large
TAPER CRIMP 45 AUTO	.451	546555	II	046555	044179	044556	044179	—	#45 / 390606	#45 / 392645	Lg Pstl / 095312	095334	#19 / 390961	Large
COWBOY 45 COLT	.452	546581	III	046583	044168	044594	—	—	#32 / 390572	#32 / 392632	Lg Pstl / 095312	095334	#19 / 390961	Large
45 COLT	.452	546582	II	046583	044151	044556	—	—	#32 / 390572	#32 / 392632	Lg Pstl / 095312	095334	#19 / 390961	Large
45 SCHOFIELD	.452	546546	IV	—	—	—	—	—	#41 / 390581	— / —	Lg Pstl / 095312	095334	#19 / 390961	Large
454 CASULL	.452	546584	V	046584	044151	044556	—	044588	#32 / 390572	#32 / 392632	Lg Pstl / 095312	095334	#19 / 390961	Small
460 S&W	.452	546583	V	046720	044721	044719	—	044722	#46 / 390602	#46 / 392646	Lg Rfl / 095316	095334	#19 / 390961	Large
455 WEBLEY	.455	—	—	—	—	—	—	—	#51 / 390601	— / —	Lg Pstl / 095312	N/A	#19 / 390961	Large
480 RUGER/475 LINB	.475	546547	V	046585	044158	044586	—	044174	#14 / 390554	#14 / 392614	Lg Pstl / 095312	N/A	#23 / 390939	Large
50 ACTION EXP	.500	546580	II	046581	044155	044582	—	—	#40 / 390640	— / —	Lg Rfl / 095316	N/A	#50 / 390937	Large
500 S&W	.500	546585	V	046699	044700	044701	—	044702	#44 / 390584	#44 / 392644	Lg Rfl / 095316	N/A	#50 / 390937	Large
500 LINEBAUGH	.510	546587	IV	—	—	—	—	—	#25 / 390565	— / —	Lg Rfl / 095316	N/A	#50 / 390937	Large

APPENDIX A

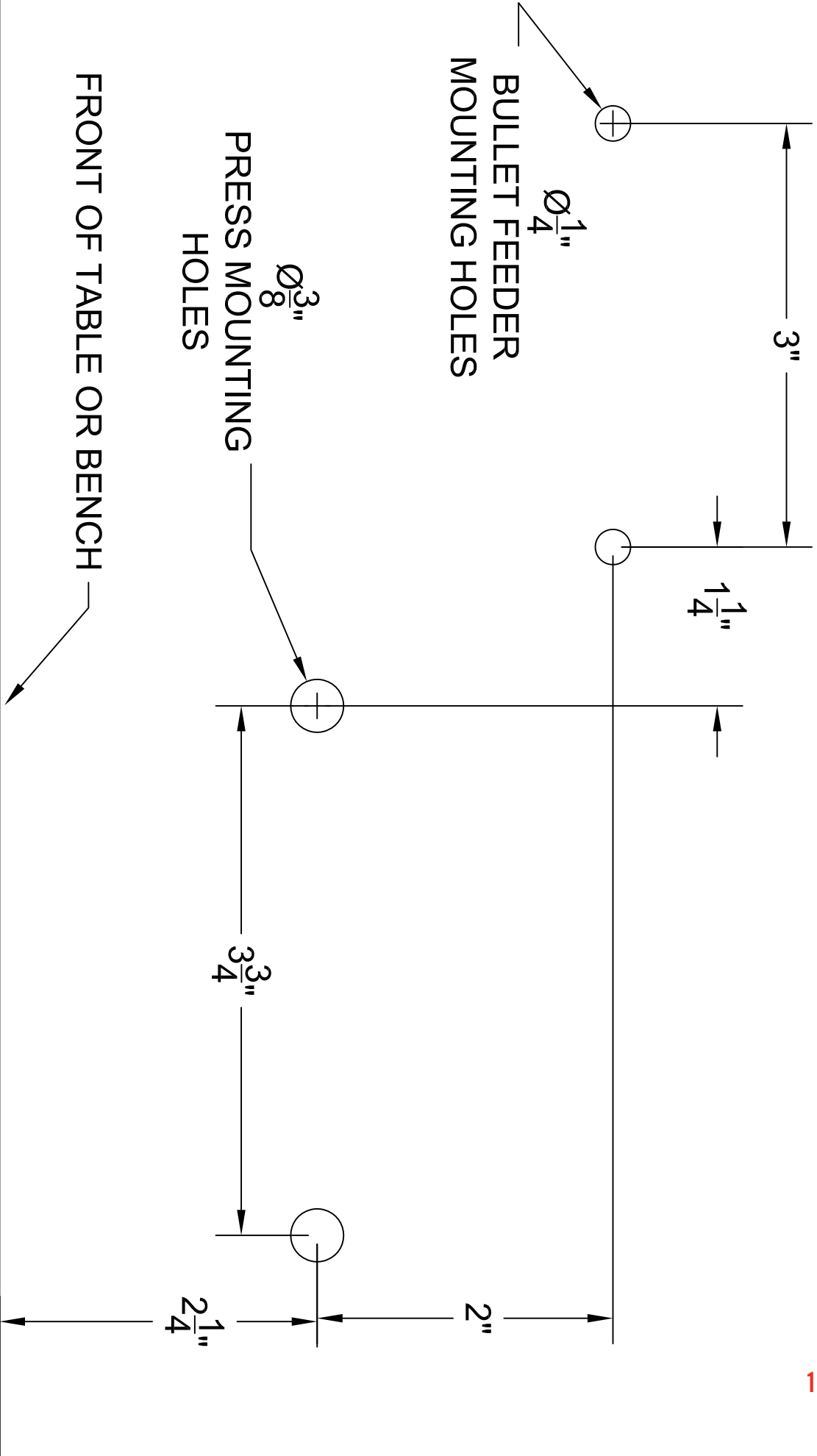

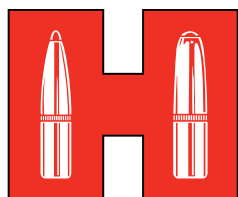

Hornady[®]
Accurate. Deadly. Dependable.

P.O. Box 1848, Grand Island, Nebraska 68802-1848
308-382-1390 • 800-338-3220 • Fax: 308-382-5761
www.hornady.com • Hornady.com/contact_us